

TECHNICAL CATALOG

A COMPANY OF MUELLER INDUSTRIES 

Mueller Refrigeration is a global leader in the design and manufacturing of premium-performance valves, protection devices, and brass fittings for various OEM customers in the commercial HVAC/R industry. While maintaining industry certifications, such as UL/cUL and CE, we also offer RoHS compliance for an extensive line of products. As a matter of company policy, all of our products are built to exceed current industry standards to guarantee reliable performance when using new-era refrigerants that operate at higher temperatures and pressures than many industry standards require. Our sophisticated in-house engineering and lab resource capabilities allow us to provide continuous improvement of existing products while addressing new product development and innovation. We specialize in finding solutions to our customer's most complex HVAC/R problems and applications, and we welcome new engineering and manufacturing challenges.

Mission

We are a quality manufacturer and supplier of refrigerant valves, components, and value-added assemblies to the HVAC and refrigeration market.

We will be a global supplier of diversified valves, components, and value-added assemblies achieving growth and top performance through:

Excellent customer service.

Creative and innovative advancements, and

Maximizing our core manufacturing capabilities.

"RELENTLESS PURSUIT OF EXCELLENCE"

Sales/Customer Service

Mueller Refrigeration, LLC

121 Rogers Street

Hartsville, TN 37074

Phone: 615-374-2124

Phone: 800-251-8983

Fax: 615-375-0932

www.muellerrefrigeration.com

Changzhou Mueller Refrigeration

12B GDH Changzhou Riverside Industrial Park

NO16 Chuangy Rd

Xinbei District, Changzhou, Jiangsu

Phone: 0086-0519-68887126

Fax: 0086-0519-68887133

Table of Contents

CYCLEMASTER® Ball Valves

Standard	6
Standard With Access Port	7
IBV Series	8
Transcritical CO2	9
Subcritical CO2	10
FTG x FTG	11
Unibody Flare x ODS	12
Unibody Female x Male Flare	13
Unibody ODS x ODS	14
3-Way	15
Actuated	16
Accessories	18

Check Valves

Inline	21
90° Angle	22
Magnetic	23
Piston	24
Four-Bolt	25

Brass Compressor Valves

Double Port, 45° Flare	26
Double Port, Solder	27
Straight Port, 45° Flare	28
Straight Port, Solder	29
Flange Union, Solder	30
Four-Bolt Mounting, Solder	31
Four-Bolt Mounting, Access Port	32

Packed Line Valves

Angle, Backseating	33
Angle, Non-Backseating	34
Two-Way	36

Transducer Valves

Transducer Valves	37
-------------------	----

Packless Diaphragm Valves

Angle	38
Straight	39

Brass Angle Isolation Valves

Solder to Rotolock	40
Solder to Solder	41

Pressure Relief Valves

Selection Process	42
Certification	44
Angle NPTFE to Flare	45
Atmospheric - NPTFE Inlet	46
Internal	47
Straight Thru	48

Rupture Disc and Pressure Gauge

NPTFE X NPTFI	50
---------------	----

RELIEFMASTER® Manifold

Change-Over Manifold	51
Ball Valve Manifold	52

Fusible Pipe Plugs, Connectors & Bushings

Fusible Pipe Plugs, Connectors & Bushings	53
---	----

DRYMASTER® Filter Driers

High Capacity Liquid Line	54
Suction Line	56
Heat Pump Driers	57
Replaceable Core Shells	58
48 Cubic Inch Cores	59

Sight Glass/ Moisture Indicators

Hermetically Sealed, Solder x Solder	60
Replaceable Element, Copper Body, Solder x Solder	61
Hermetically Sealed, Flare	62

Table of Contents

Strainers

Copper Inline, Solder 73

45° Flare Fittings

45° Flare Fittings 64

Copper Flare Bonnets and Gaskets 65

90° Elbows 66

Adaptors 67

Nuts 68

Plugs 69

Tees 70

Connectors 71

Forged Brass Solder Flanges And Gaskets

Forged Brass Solder Flanges And Gaskets 74

Component Parts

Seal Caps and Gaskets 75

Competitive Cross Reference

Ball Valves 76

Check Valves 77

Line Valves 78

Diaphragm Valves 79

Pressure Relief Valves 80

Filter Driers - Liquid Line 81

Filter Driers - Suction Line and Heat Pump 82

Replaceable Cores and Shells 83

Sight Glass/Moisture Indicators 84

45° Flare Fittings 85

Inactive Part Replacements 86

Order Schedule and Return Policy 88

Terms and Conditions of Sale 89

Index 91

CYCLEMASTER® Ball Valves

Standard



Features:

- Design Pressure (DP) / Maximum abnormal pressure (MAP): Up to 775 psig, 53 bar
- Continuous operating temperature (COT): -40°F/300°F, -40°C/149°C
- Contact factory or visit website for compatibility with CFC, HCFC, HFC and HFO refrigerants and oils
- Full port construction to match line size ID
- Internally equalized ball design
- Rupture-proof encapsulated stem
- Bi-directional flow
- MCM Seal Technology
- UL/cUL Listed, Conforms to Pressure Equipment Directive 2014/68/EU

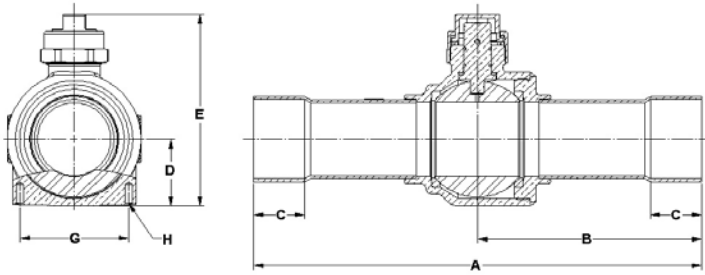

Part Number	Size		Cv	Kv	A		B		C Min		D		E		G **		H **		Port (in)		MAP		Wt		Seal Cap Kit
	in	mm			in	mm	in	mm	in	mm	in	mm	in	mm	in	mm	in	mm	in	mm	psi	bar	lb	kg	
AP17859	‡	1/4	6	1.0	1	5.50	140	2.98	76	0.31	8	0.54	14	2.23	57	0.87	22	M4 X 0.7	0.50	775	53	0.48	0.22	A 17842	
AP17860C	‡	3/8	10	4.3	4	5.50	140	2.98	76	0.31	8	0.54	14	2.23	57	0.87	22	M4 X 0.7	0.50	775	53	0.48	0.22	A 17842	
AP17861C	‡	1/2	13	6.2	5	6.35	161	3.41	87	0.38	10	0.54	14	2.23	57	0.87	22	M4 X 0.7	0.50	775	53	0.53	0.24	A 17842	
AP17862C	‡	5/8	17	12.1	10	6.35	161	3.41	87	0.50	13	0.54	14	2.23	57	0.87	22	M4 X 0.7	0.50	775	53	0.50	0.23	A 17842	
AP17863	‡	3/4	19	19.0	16	7.45	189	3.89	99	0.62	16	0.72	18	2.66	68	1.18	30	M4 X 0.7	0.75	775	53	0.88	0.40	A 17843	
AP17864C	‡	7/8	22	27.5	24	7.45	189	3.89	99	0.75	19	0.72	18	2.66	68	1.18	30	M4 X 0.7	0.75	775	53	0.93	0.42	A 17843	
AP17865	‡	1 1/8	29	54.0	47	8.42	214	4.21	107	0.91	23	1.00	25	3.15	80	1.50	38	M4 X 0.7	1.00	775	53	1.61	0.73	A 17843	
A 17866		1 3/8	35	89.1	77	10.00	254	5.00	127	0.97	25	1.17	30	3.72	94	1.89	48	M6 X 1.0	1.25	775	53	2.59	1.17	A 17844	
A 17867		1 5/8	41	114.0	99	11.00	279	5.50	140	1.09	28	1.38	35	4.12	105	2.17	55	M6 X 1.0	1.50	775	53	3.64	1.65	A 17844	
A 17868		2 1/8	54	244.0	211	12.00	305	6.00	152	1.34	34	1.79	45	5.14	131	2.91	74	M6 X 1.0	2.00	700	48	8.02	3.64	A 17845	
A 17869		2 5/8	67	401.0	347	13.50	343	6.75	171	1.47	37	2.19	56	5.92	150				2.44	700	48	13.40	6.08	A 17845	
A 17870		3 1/8	79	553.0	478	16.00	406	8.00	203	1.66	42	2.69	68	7.03	179				3.00	700	48	21.31	9.67	A 17846	
A 17871	*	2 5/8	67	230.0	199	12.00	305	6.00	152	1.47	37	1.79	45	5.14	131	2.91	74	M6 X 1.0	2.00	700	48	8.46	3.84	A 17845	
A 17872	*	3 1/8	79	143.0	124	12.00	305	6.00	152	1.66	42	1.79	45	5.14	131	2.91	74	M6 X 1.0	2.00	700	48	9.12	4.13	A 17845	
B 34909	***	3 5/8	92			13.10	333	6.50	165	1.91	49	2.69	68	7.03	179				3.00	700	48	19.91	9.03	A 17846	
B 34910	***	4 1/8	105			14.50	368	7.20	183	2.16	55	2.69	68	7.03	179				3.00	700	48	21.00	9.53	A 17846	

- * Reduced Port
 ** Where Applicable
 *** Consult Factory
 ‡ Standard product offering includes drilled/ tapped feature
 Prefix AP Drilled/ tapped

CYCLEMASTER® Ball Valves

Standard With Access Port

Features:

- Design Pressure (DP) / Maximum abnormal pressure (MAP): Up to 775 psig, 53 bar
- Continuous operating temperature (COT): -40°F/300°F, -40°C/149°C
- Contact factory or visit website for compatibility with CFC, HCFC, HFC and HFO refrigerants and oils
- Full port construction to match line size ID
- Internally equalized ball design
- Rupture-proof encapsulated stem
- Bi-directional flow
- MCM Seal Technology
- UL/cUL Listed, Conforms to Pressure Equipment Directive 2014/68/EU

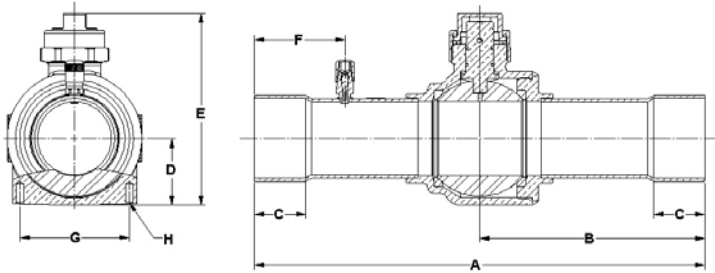

Part Number	Size		Cv	Kv	A		B		C Min		D		E		F		G **		H **		Port (in)	MAP		Wt		Seal Cap Kit
	in	mm			in	mm	in	mm	in	mm	in	mm	in	mm	in	mm	in	mm	in	mm		psig	bar	lb	kg	
AQ17859 ‡	1/4	6	1.0	1	5.50	140	2.98	76	0.31	8	0.54	14	2.23	57	1.16	29	0.87	22	M4 X 0.7	0.50	775	53	0.52	0.23	A 17842	
AQ17860C ‡	3/8	10	4.3	4	5.50	140	2.98	76	0.31	8	0.54	14	2.23	57	1.16	29	0.87	22	M4 X 0.7	0.50	775	53	0.52	0.24	A 17842	
AQ17861C ‡	1/2	13	6.2	5	6.35	161	3.41	87	0.38	10	0.54	14	2.23	57	1.21	31	0.87	22	M4 X 0.7	0.50	775	53	0.53	0.24	A 17842	
AQ17862C ‡	5/8	17	12.1	10	6.35	161	3.41	87	0.50	13	0.54	14	2.23	57	1.35	34	0.87	22	M4 X 0.7	0.50	775	53	0.54	0.24	A 17842	
AQ17863 ‡	3/4	19	19.0	16	7.45	189	3.89	99	0.62	16	0.72	18	2.66	68	1.47	37	1.18	30	M4 X 0.7	0.75	775	53	0.92	0.42	A 17843	
AQ17864C ‡	7/8	22	27.5	24	7.45	189	3.89	99	0.75	19	0.72	18	2.66	68	1.60	41	1.18	30	M4 X 0.7	0.75	775	53	0.96	0.43	A 17843	
AQ17865 ‡	1 1/8	29	54.0	47	8.42	214	4.21	107	0.91	23	1.00	25	3.15	80	1.74	44	1.50	38	M4 X 0.7	1.00	775	53	1.66	0.75	A 17843	
AC17866	1 3/8	35	89.1	77	10.00	254	5.00	127	0.97	25	1.17	30	3.72	94	2.04	52	1.89	48	M6 X 1.0	1.25	775	53	2.62	1.19	A 17844	
AC17867	1 5/8	41	114.0	99	11.00	279	5.50	140	1.09	28	1.38	35	4.12	105	2.25	57	2.17	55	M6 X 1.0	1.50	775	53	3.68	1.67	A 17844	
AC17868	2 1/8	54	244.0	211	12.00	305	6.00	152	1.34	34	1.79	45	5.14	131	2.41	61	2.91	74	M6 X 1.0	2.00	700	48	8.09	3.67	A 17845	
AC17869	2 5/8	67	401.0	347	13.50	343	6.75	171	1.47	37	2.19	56	5.92	150	2.85	72				2.44	700	48	13.81	6.26	A 17845	
AC17870	3 1/8	79	553.0	478	16.00	406	8.00	203	1.66	42	2.69	68	7.03	179	3.41	87				3.00	700	48	21.42	9.72	A 17846	
AC17871 *	2 5/8	67	230.0	199	12.00	305	6.00	152	1.47	37	1.79	45	5.14	131	2.48	63	2.91	74	M6 X 1.0	2.00	700	48	8.71	3.95	A 17845	
AC17872 *	3 1/8	79	143.0	124	12.00	305	6.00	152	1.66	42	1.79	45	5.14	131	2.66	68	2.91	74	M6 X 1.0	2.00	700	48	9.23	4.18	A 17845	

* Reduced Port

** Where Applicable

*** Consult Factory

‡ Standard product offering includes drilled/ tapped feature

Prefix AQ Drilled/ tapped

CYCLEMASTER® Ball Valves

IBV Series



Features:

- Design Pressure (DP) / Maximum abnormal pressure (MAP): 775 psig, 53 bar
- Continuous operating temperature (COT): -40°F/300°F, -40°C/149°C
- Contact factory or visit website for compatibility with CFC, HCFC, HFC and HFO refrigerants and oils
- Full port construction to match line size ID
- Internally equalized ball design
- Rupture-proof encapsulated stem
- MCM Seal Technology
- UL/cUL Listed, Conforms to Pressure Equipment Directive 2014/68/EU

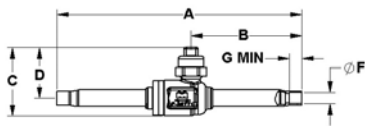

Drawing A

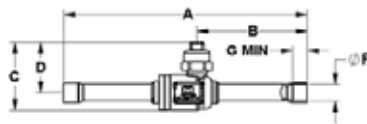

Drawing B

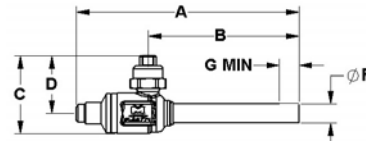

Drawing C

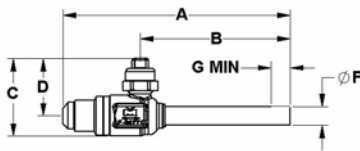

Drawing D

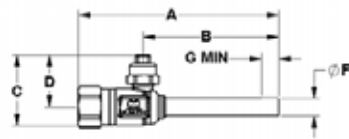

Drawing E

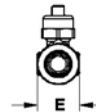

Solder

Part Number	Size	A		B		C		D		E		F		G Min		Wt	Drawing	2 Piece Seal Cap Assembly	
		in	mm	in	mm	in	mm	in	mm	in	mm	in	mm	in	mm				lb
A 17855	1/4 ODS	5.50	140	2.50	64	1.54	39	1.14	29	0.81	21	0.250	6	0.25	6	0.25	0.12	A	A 17841
A 17856	3/8 ODS	5.50	140	2.50	64	1.54	39	1.14	29	0.81	21	0.375	10	0.31	8	0.26	0.12	B	A 17841

FL x ODE

Part Number	Size	A		B		C		D		E		F		G Min		Wt	Drawing	Flare Fitting Seal Cap	Valve Core **	Flare Fitting Seal Cap Kit ***	2 Piece Seal Cap Assembly	
		in	mm	in	mm	in	mm	in	mm	in	mm	in	mm	in	mm							lb
A 18673	1/4 FL X 3/8 ODE	4.38	111	2.97	75	1.54	39	1.14	29	0.81	21	0.375	10	0.38	10	0.26	0.12	C	A 16447	P 25998	A 18726	A 17841
A 18674	3/8 FL X 3/8 ODE	4.50	114	2.97	75	1.54	39	1.14	29	0.81	21	0.375	10	0.38	10	0.28	0.13	D	A 16448			A 17841

NPTFI X ODE

Part Number	Size	A		B		C		D		E		F		G Min		Wt	Drawing	Plug for 1/4 NPTF	2 Piece Seal Cap Assembly	
		in	mm	in	mm	in	mm	in	mm	in	mm	in	mm	in	mm					lb
A 18675	1/4 NPTFI X 3/8 ODE	4.38	111	2.97	75	1.54	39	1.14	29	0.81	21	0.375	10	0.38	10	0.28	0.13	E	P 34707	A 17841

* Assembled finger tight

** Installation torque 1-3 in/lbs

*** Includes seal cap and valve stem

1) Stem torque to rotate ball: 15 in-lbs maximum

2) Torque for installing ball valves with 1/4" flare connection: 8 - 10 ft-lbs

3) Torque for installing ball valves with 3/8" flare connection: 15 - 25 ft-lbs

CYCLEMASTER® Ball Valves

Transcritical CO2

Features:

- Design Pressure (DP) / Maximum abnormal pressure (MAP): 2031 psi, 140 bar
- Continuous operating temperature (COT): -40°F/300°F, -40°C/149°C
- Designed for transcritical CO2 systems
- Bi-directional flow
- Brass body with copper-iron alloy connections
- Bleed hole in ball allows for the support of gas pressure without stressing other components
- Full port construction to match line size
- Rupture-proof, internally-loaded stem
- Specially selected o-ring material compatible for CO2 operating conditions
- UL/cUL Listed, conforms to Pressure Equipment Directive 2014/68/EU and EN 378-2



Solder Cup Connection

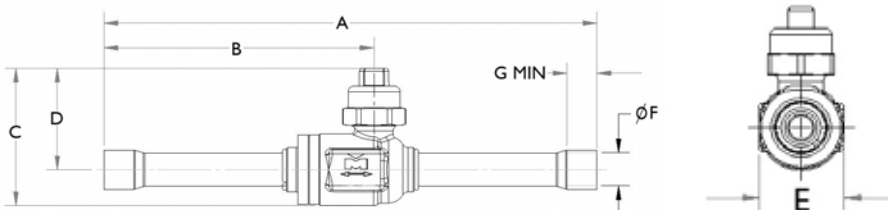

Part Number	Size		Cv	Kv	A		B		C Min		D		E		G **		H **		Port (in)	Wt		Seal Cap Kit
	in	mm			in	mm	in	mm	in	mm	in	mm	in	mm	in	mm	lb	kg				
A 17856XHP	3/8	10	4.3	4	5.50	140	3.01	76	1.54	39	1.14	29	0.80	20	0.31	8	M4 X 0.7	0.50	0.24	0.11	A 17842	
A 17861XHP	1/2	13	6.2	5	6.35	161	3.41	87	2.23	57	1.69	43	1.14	29	0.38	10	M4 X 0.7	0.50	0.54	0.24	A 17842	
A 17862XHP	5/8	17	12.1	10	6.35	161	3.41	87	2.23	57	1.69	43	1.14	29	0.50	13	M4 X 0.7	0.50	0.53	0.24	A 17842	
A 17864XHP	7/8	22	27.5	24	7.45	189	3.88	99	3.35	85	2.07	53	1.76	45	0.75	19	M4 X 0.7	0.75	1.59	0.72	A 17843	
A 17865XHP	1 1/8	29	54.0	47	8.41	214	4.33	110	3.97	101	2.50	64	2.26	57	0.91	23	M4 X 0.7	1.00	3.06	1.39	A 17843	

Straight End Connection

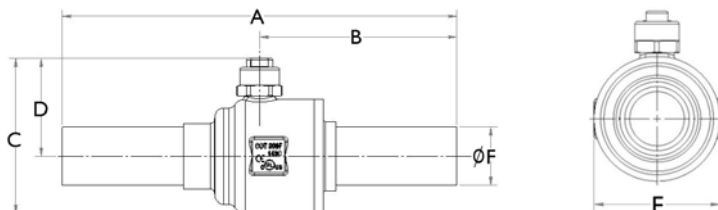

Part Number	Size		Cv	Kv	A		B		C Min		D		E		G **		H **		Port (in)	Wt		Seal Cap Kit
	in	mm			in	mm	in	mm	in	mm	in	mm	in	mm	in	mm	lb	kg				
AF17866XHP	1 3/8	35	89.1	77	10.00	254	5.00	127	3.92	100	2.55	65	2.76	70	0.00	0	M6 X 1.0	1.25	4.55	2.06	A 17844	
AF17867XHP	1 5/8	41	114.0	99	11.00	279	5.50	140	4.33	110	2.74	70	3.18	81	0.00	0	M6 X 1.0	1.50	6.74	3.06	A 17844	
AF17868XHP	2 1/8	54	244.0	211	12.00	305	6.00	152	5.53	140	3.47	88	4.14	105	0.00	0	M6 X 1.0	2.00	13.66	6.20	A 17845	

XHP Female x Female Coupling available through Mueller Streamline

CYCLEMASTER® Ball Valves

Subcritical CO2



Features:

- Design Pressure (DP) / Maximum abnormal pressure (MAP): 870 psig, 60 bar
- Continuous operating temperature (COT): -40°F/300°F, -40°C/149°C
- Designed for subcritical CO2 systems
- Bi-directional flow
- Brass body with copper-iron alloy connections
- Full port construction to match line size
- Rupture-proof, internally-loaded stem
- Specially selected o-ring material compatible for CO2 operating conditions
- UL/cUL Listed, conforms to Pressure Equipment Directive 2014/68/EU and EN 378-2

Solder Connections

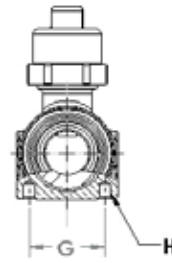
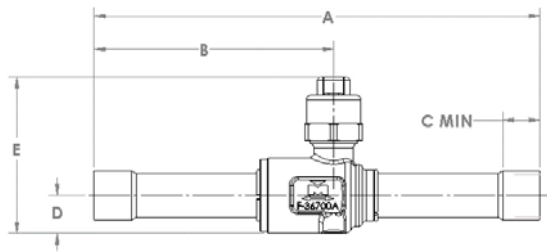

Part Number	Size		Cv	Kv	A		B		C Min		D		E		G **		H **		Port (in)	Wt		Seal Cap Kit
	in	mm			in	mm	in	mm	in	mm	in	mm	in	mm	in	mm	in	mm		lb	kg	
AP17859HP	1/4	6	1.0	1	5.50	140	2.98	76	0.31	8	0.54	14	2.23	57	0.87	22	M4 X 0.7	0.50	0.67	0.30	A 17842	
AP17860HP	3/8	10	4.3	4	5.50	140	2.98	76	0.31	8	0.54	14	2.23	57	0.87	22	M4 X 0.7	0.50	0.48	0.22	A 17842	
AP17861HP	1/2	13	6.2	5	6.35	161	3.41	87	0.38	10	0.54	14	2.23	57	0.87	22	M4 X 0.7	0.50	0.53	0.24	A 17842	
AP17862HP	5/8	17	12.1	10	6.35	161	3.41	87	0.50	13	0.54	14	2.23	57	0.87	22	M4 X 0.7	0.50	0.50	0.23	A 17842	
AP17863HP	3/4	19	19.0	16	7.45	189	3.89	99	0.62	16	0.72	18	2.66	68	1.18	30	M4 X 0.7	0.75	1.40	0.64	A 17843	
AP17864HP	7/8	22	27.5	24	7.45	189	3.89	99	0.75	19	0.72	18	2.66	68	1.18	30	M4 X 0.7	0.75	0.93	0.42	A 17843	
AP17865HP	1 1/8	29	54.0	47	8.41	214	4.21	107	0.91	23	1.00	25	3.15	80	1.50	38	M4 X 0.7	1.00	1.61	0.73	A 17843	

NPTFI X ODE Connections

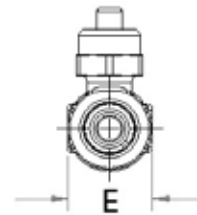
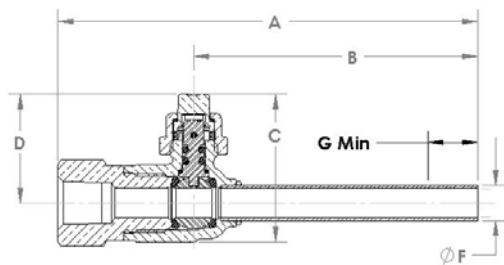

Part Number	Size		Cv	Kv	A		B		C Min		D		E		G **		Wt		Seal Cap Kit	
	in	mm			in	mm	in	mm	in	mm	in	mm	in	mm	in	mm	lb	kg		
A 18675HP	1/4	6	0.0	0	4.38	111	2.97	75	1.54	39	1.14	29	0.81	21	0.38	10		0.29	0.13	A 17841

** Where Applicable

CYCLEMASTER® Ball Valves

FTG X FTG

Features:

- Design Pressure (DP) / Maximum abnormal pressure (MAP): 775 psig, 53 bar
- Continuous operating temperature (COT): -40°F/300°F, -40°C/149°C
- Contact factory or visit website for compatibility with CFC, HCFC, HFC and HFO refrigerants and oils
- Full port construction to match line size ID
- Internally equalized ball design
- Rupture-proof encapsulated stem
- MCM Seal Technology
- UL/cUL Listed, Conforms to Pressure Equipment Directive 2014/68/EU

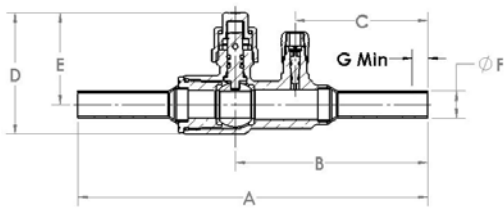

Part Number	Size	Cv	Kv	A		B		C		D		E		F		G Min		Wt		Seal Cap Kit	
				in	mm	in	mm	in	mm	in	mm	in	mm	in	mm	in	mm	lb	kg		
A 18959	1/4	6	1.0	1	6.51	165	3.62	92	2.52	64	2.23	57	1.69	43	0.25	6	0.38	10	0.69	0.31	A 17842
A 18960	3/8	10	4.0	3	6.15	156	3.44	87	2.34	59	2.23	57	1.69	43	0.38	10	0.38	10	0.61	0.28	A 17842
A 18961	1/2	13	5.0	4	6.43	163	3.54	90	2.44	62	2.23	57	1.69	43	0.50	13	0.44	11	0.59	0.27	A 17842
A 18962	5/8	17	10.0	9	6.07	154	3.36	85	2.26	57	2.23	57	1.69	43	0.63	16	0.56	14	0.62	0.28	A 17842

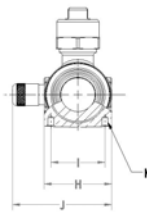
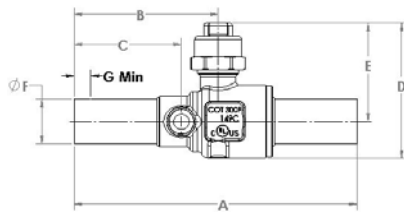

Part Number	Size	Cv	Kv	A		B		C		D		E		F		G Min		H		I		J		K		Wt		Seal Cap Kit
				in	mm	in	mm	in	mm	in	mm	in	mm	in	mm	in	mm	in	mm	in	mm	in	mm	in	mm	in	mm	
A 18963	3/4	19	19.0	16	6.12	155	3.11	79	2.39	61	2.66	68	1.94	49	0.75	19	0.69	18	2.17	55	1.18	30	2.17	55	M4 X 0.7	0.86	0.39	A 17843
A 18964	7/8	22	27.5	24	5.54	141	2.82	72	2.10	53	2.66	68	1.94	49	0.88	22	0.81	21	2.17	55	1.18	30	2.17	55	M4 X 0.7	0.87	0.39	A 17843
A 18965	1 1/8	29	54.0	47	7.62	194	4.15	105	3.10	79	3.15	80	2.15	55	1.13	29	0.97	25	2.58	66	1.50	38	2.58	66	M4 X 0.7	1.65	0.75	A 17843
A 18966	1 3/8	35	89.0	77	7.74	197	4.10	104	3.06	78	3.75	95	2.55	65	1.38	35	1.03	26	2.86	73	1.89	48	2.86	73	M4 X 0.7	2.37	1.07	A 17843

Multi Split Ball Valves

Unibody Flare x ODS

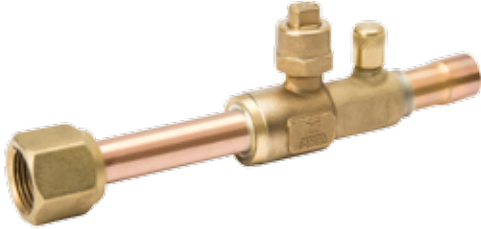

Features:

- Design Pressure (DP) / Maximum abnormal pressure (MAP): 775 psig, 53 bar
- Continuous operating temperature (COT): -40°F/300°F, -40°C/149°C
- Contact factory or visit website for compatibility with CFC, HCFC, HFC and HFO refrigerants and oils
- Full port construction to match line size ID
- Internally equalized ball design
- Rupture-proof encapsulated stem
- MCM Seal Technology
- UL/cUL Listed, Conforms to Pressure Equipment Directive 2014/68/EU

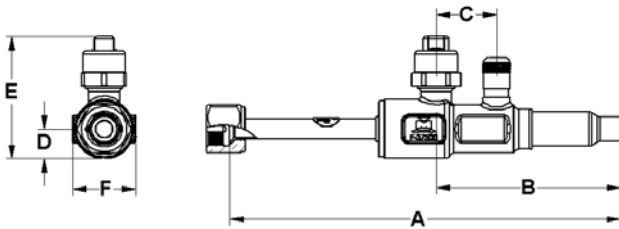

Drawing A

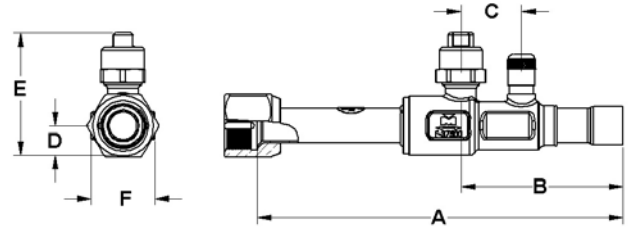

Drawing B

Valve Part Number	Valve Insulation Kit Part Number	Size		A		B		C		D		E		F		Wt		Drawing
		in	mm	in	mm	in	mm	in	mm	in	mm	in	mm	in	mm	lb	kg	
A 18941	A 18611U	1/4	6	7.17	182	3.36	85	1.10	28	0.54	14	2.23	57	1.16	29	0.64	0.29	A
A 18942	A 18612U	3/8	10	7.12	181	3.36	85	1.10	28	0.54	14	2.23	57	1.16	29	0.70	0.32	A
A 18943	A 18613U	1/2	13	6.71	170	2.94	75	1.10	28	0.54	14	2.23	57	1.16	29	0.73	0.33	A
A 18944	A 18614U	5/8	17	6.64	169	2.94	75	1.10	28	0.54	14	2.23	57	1.16	29	0.79	0.36	B

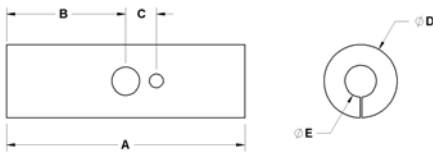

Insulation Part No.	A (in)	B (in)	C (in)	D (in)	E (in)	Thickness (in)	Wt(lb)
MSBVINSCEN	8.56	4.28	1.10	2.63	1.13	0.75	0.02

Multi Split Ball Valves

Unibody Female x Male Flare

Features:

- Design Pressure (DP) / Maximum abnormal pressure (MAP): 775 psig, 53 bar
- Continuous operating temperature (COT): -40°F/300°F, -40°C/149°C
- Contact factory or visit website for compatibility with CFC, HCFC, HFC and HFO refrigerants and oils
- Full port construction to match line size ID
- Internally equalized ball design
- Rupture-proof encapsulated stem
- MCM Seal Technology
- UL/cUL Listed, Conforms to Pressure Equipment Directive 2014/68/EU

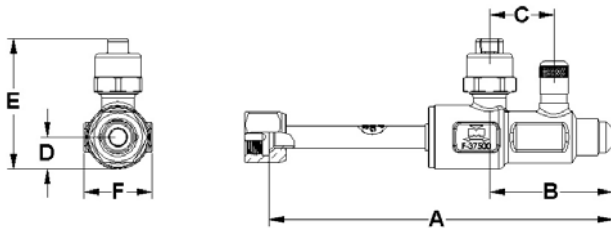

Valve Part Number	Valve Insulation Kit Part Number	Size	A		B		C		D		E		F		Wt		
			in	mm	in	mm	in	mm	in	mm	in	mm	in	mm	lb	kg	
A 18945	A 18567U	1/4	6	5.86	149	2.05	52	1.10	28	0.54	14	2.23	57	1.16	29	0.62	0.28
A 18946	A 18568U	3/8	10	5.86	149	2.10	53	1.10	28	0.54	14	2.23	57	1.16	29	0.69	0.31
A 18947	A 18569U	1/2	13	5.98	152	2.21	56	1.10	28	0.54	14	2.23	57	1.16	29	0.76	0.34
A 18948	A 18570U	5/8	17	5.98	152	2.28	58	1.10	28	0.54	14	2.23	57	1.16	29	0.84	0.38
A 18949	A 18652U	3/8 FX 1/4 M		5.81	148	2.05	52	1.10	28	0.54	14	2.23	57	1.16	29	0.68	0.31
A 18950	A 18653U	5/8 FX 1/2 M		5.91	150	2.21	56	1.10	28	0.54	14	2.23	57	1.16	29	0.82	0.37

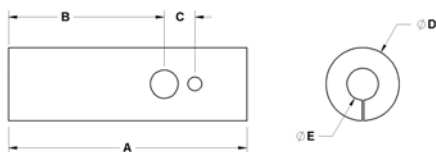

Insulation Part No.	A (in)	B (in)	C (in)	D (in)	E (in)	Thickness (in)	Wt(lb)
MSBVINS	8.56	6.56	1.10	2.63	1.13	0.75	0.10

Multi Split Ball Valves

Unibody ODS x ODS



Features:

- Design Pressure (DP) / Maximum abnormal pressure (MAP): 775 psig, 53 bar
- Continuous operating temperature (COT): -40°F/300°F, -40°C/149°C
- Contact factory or visit website for compatibility with CFC, HCFC, HFC and HFO refrigerants and oils
- Full port construction to match line size ID
- Internally equalized ball design
- Rupture-proof encapsulated stem
- MCM Seal Technology
- UL/cUL Listed, Conforms to Pressure Equipment Directive 2014/68/EU

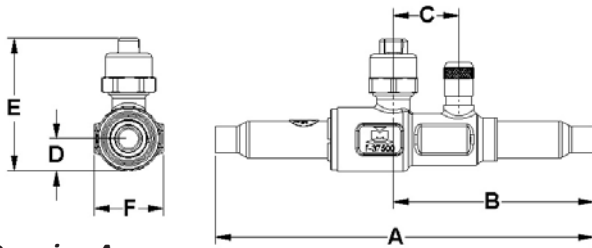

Drawing A

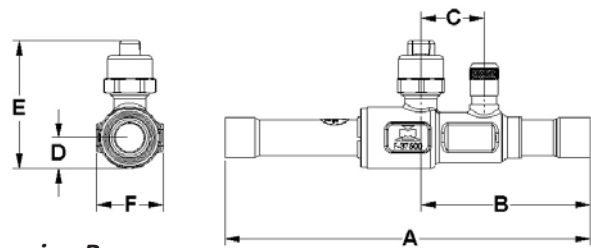

Drawing B

Valve Part Number	Valve Kit Part Number	Insulation	Size		A		B		C		D		E		F		Wt		Drawing
			in	mm	in	mm	in	mm	in	mm	in	mm	in	mm	in	mm	lb	kg	
A 18937	A 18571U		1/4	6	6.35	161	3.36	85	1.10	28	0.54	14	2.23	57	1.16	29	0.60	0.27	A
A 18938	A 18572U		3/8	10	6.35	161	3.36	85	1.10	28	0.54	14	2.23	57	1.16	29	0.62	0.28	A
A 18939	A 18573U		1/2	13	6.35	161	2.94	75	1.10	28	0.54	14	2.23	57	1.16	29	0.61	0.28	A
A 18940	A 18574U		5/8	17	6.35	161	2.94	75	1.10	28	0.54	14	2.23	57	1.16	29	0.61	0.27	B

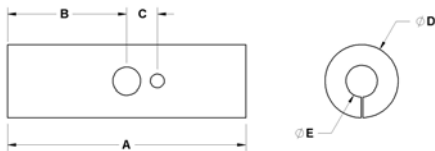

Insulation Part No.	A (in)	B (in)	C (in)	D (in)	E (in)	Thickness (in)	Wt(lb)
MSBVINSCEN	8.56	4.28	1.10	2.63	1.13	0.75	0.02

CYCLEMASTER® Ball Valves

3-Way

Features:

- Design Pressure (DP) / Maximum abnormal pressure (MAP): 700 psig, 48 bar
- Continuous operating temperature (COT): -40°F/300°F, -40°C/149°C
- Contact factory or visit website for compatibility with CFC, HCFC, HFC and HFO refrigerants and oils
- Full port construction to match line size ID
- Internally equalized ball design
- Rupture-proof encapsulated stem
- MCM Seal Technology
- UL/cUL Listed, Conforms to Pressure Equipment Directive 2014/68/EU

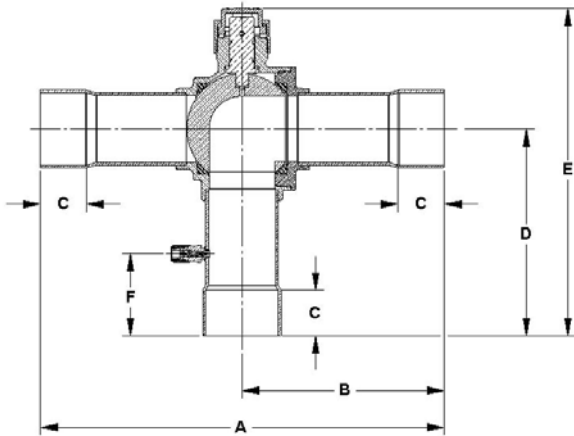

Part Number	Size		Cv	Kv	A		B		C	D		E		F		Port (in)	Wt		Seal Cap Kit	
	in	mm			in	mm	in	mm		in	mm	in	mm	in	mm		lb	kg		
AU17860	3/8	10	2.23	2	5.50	140	2.97	75	0.31	8	2.61	66	4.16	106	1.16	29	0.50	0.73	0.33	A 17842
AU17861	1/2	13	3.94	3	6.38	162	3.42	87	0.38	10	3.05	77	4.60	117	1.21	31	0.50	0.74	0.33	A 17842
AU17862	5/8	17	4.63	4	6.38	162	3.42	87	0.50	13	3.05	77	4.60	117	1.35	34	0.50	0.74	0.34	A 17842
AU17863	3/4	19	11.90	10	7.47	190	3.91	99	0.62	16	3.65	93	5.86	149	1.47	37	0.75	1.40	0.64	A 17843
AU17864	7/8	22	10.89	9	7.47	190	3.91	99	0.75	19	3.65	93	5.86	149	1.60	41	0.75	1.52	0.69	A 17843
AU17865	1 1/8	29	19.33	17	8.41	214	4.33	110	0.91	23	4.01	102	6.39	162	1.74	44	1.00	2.82	1.28	A 17844
A 17545	1 3/8	35	31.06	27	10.00	254	5.07	129	0.97	25	4.92	125	7.89	200	2.04	52	1.25	4.97	2.25	A 17845
A 17546	1 5/8	41	44.69	39	11.00	279	5.53	140	1.09	28	5.46	139	8.61	219	2.25	57	1.50	7.17	3.25	A 17845
AU17868	2 1/8	54	76.32	66	11.86	301	5.95	151	1.34	34	6.06	154	9.58	243	2.41	61	1.93	8.27	3.75	A 17845
AU17871 *	2 5/8	67	69.85	60	11.90	302	5.97	152	1.47	37	6.08	154	9.60	244	2.48	63	1.93	8.80	3.99	A 17845

* Reduced Port

CYCLEMASTER® Ball Valves

Actuated

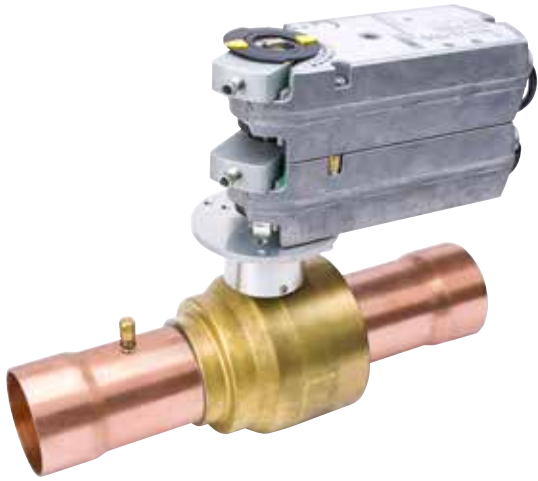

Features:

- Design Pressure (DP) / Maximum abnormal pressure (MAP): Up to 775 psig, 53 bar
- Power Supply: 24 VAC
- Actuator Ambient Temperature: -25°F to 130°F, -32°C to 54°C
- Contact factory or visit website for compatibility with CFC, HCFC, HFC and HFO refrigerants and oils
- Valve Refrigerant Temperature: -40°F to 300°F, -40°C to 149°C
- Full shutoff capability
- Gradual open/close stops line hammer
- Remote operating capability
- Removable actuator for quick change replacement
- Manual override and valve positioning
- Electronic overload protection
- UL/cUL Listed, Conforms to Pressure Equipment Directive 2014/68/EU

Actuated Standard

Part Number	Size		Cv	Kv	A		B		C Min		D		MAP		Wt		Motor	Hub Kit	Actuator Kit***	Heater	
	in	mm			in	mm	in	mm	in	mm	in	mm	psig	bar	lb	kg					
AW17861	1/2	13	6.20	5	4.00	102	2.36	60	3.70	94	2.76	70	775	53	2.21	1.00	1	A 18389	A 18390		
AW17862	5/8	17	12.10	10	4.00	102	2.36	60	3.70	94	2.76	70	775	53	2.38	1.08	1	A 18389	A 18390		
AW17863	3/4	19	19.00	16	4.21	107	2.36	60	3.70	94	2.76	70	775	53	2.40	1.09	1	A 18391	A 18392		
AW17864	7/8	22	27.50	24	4.21	107	2.36	60	3.70	94	2.76	70	775	53	2.42	1.10	1	A 18391	A 18392		
AW17865	1 1/8	29	54.00	47	4.58	116	2.36	60	3.70	94	2.76	70	775	53	3.10	1.41	1	A 18391	A 18392		
AW17866	1 3/8	35	89.10	77	5.05	128	2.36	60	5.91	150	3.19	81	775	53	5.53	2.51	2	A 18393	A 18394	A 18366	
AW17867	1 5/8	41	114.00	99	5.34	136	2.36	60	5.91	150	3.19	81	775	53	6.94	3.15	2	A 18393	A 18394	A 18366	
AW17868	2 1/8	54	244.00	211	6.42	163	2.66	68	8.94	227	3.94	100	700	48	13.14	5.96	3	A 18368	A 18395	A 18367	
AW17869	**	2 5/8	67	401.00	347	9.45	240	5.30	135	8.94	227	3.94	100	700	48	23.40	10.61	4	A 18400	A 18401	A 18367 (2)
AW17870	**	3 1/8	79	553.00	478	9.99	254	5.30	135	8.94	227	3.94	100	700	48	31.40	14.24	4	A 18400	A 18401	A 18367 (2)
AW17871	*	2 5/8	67	230.00	199	6.42	163	2.66	68	8.94	227	3.94	100	700	48	13.56	6.15	3	A 18368	A 18395	A 18367
AW17872	*	3 1/8	79	143.00	124	6.42	163	2.66	68	8.94	227	3.94	100	700	48	14.24	6.46	3	A 18368	A 18395	A 18367

Actuated 3-Way

Part Number	Size		Cv	Kv	A		B		C Min		D		MAP		Wt		Motor	Hub Kit	Actuator Kit***	Heater	
	in	mm			in	mm	in	mm	in	mm	psig	bar	lb	kg							
AY17861	1/2	13	3.90	3	4.18	106	2.36	60	3.70	94	2.76	70	700	48	2.28	1.03	1	A 18389	A 18390		
AY17862	5/8	17	4.60	4	4.18	106	2.36	60	3.70	94	2.76	70	700	48	2.39	1.08	1	A 18389	A 18390		
AY17863	3/4	19	11.90	10	4.50	114	2.36	60	3.70	94	2.76	70	700	48	3.50	1.59	1	A 18391	A 18392		
AY17864	7/8	22	10.90	9	4.50	114	2.36	60	3.70	94	2.76	70	700	48	3.25	1.47	1	A 18391	A 18392		
AY17865	1 1/8	29	19.30	17	5.02	128	2.36	60	5.91	150	3.19	81	700	48	5.73	2.60	2	A 18393	A 18394	A 18366	
A 17810	1 3/8	35	31.10	27	5.44	138	2.36	60	5.91	150	3.19	81	700	48	8.13	3.69	2	A 18368	A 18396	A 18366	
A 17811	1 5/8	41	44.70	39	6.22	158	2.66	68	8.94	227	3.94	100	700	48	12.00	5.44	3	A 18368	A 18395	A 18367	
AY17868	2 1/8	54	76.30	66	6.54	166	2.66	68	8.94	227	3.94	100	700	48	13.23	6.00	3	A 18368	A 18395	A 18367	
AY17871	*	2 5/8	67	69.90	60	6.54	166	2.66	68	8.94	227	3.94	100	700	48	14.09	6.39	3	A 18368	A 18395	A 18367
AY17872	*	3 1/8	79	58.20	50	6.54	166	2.66	68	8.94	227	3.94	100	700	48	14.64	6.64	3	A 18368	A 18395	A 18367

* Reduced Port

** Consists of two stacked motors operating in tandem

*** Actuator Kit includes Motor and Hub

Prefix AWS Actuator includes auxiliary switch

Prefix AYS Actuator includes auxiliary switch

Suffix -KIT Weatherproof Enclosure Kit includes ball valve, actuator and hub kit with enclosure

Warning Heater assembly required for low temperature applications

Warning Motors not for use in wet or applications where moisture will condense on motor

CYCLEMASTER® Ball Valves

Actuated

Actuated Standard

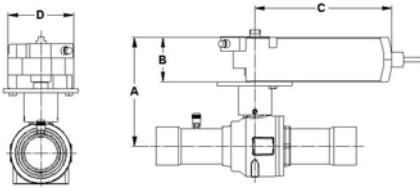

Actuated 3-Way

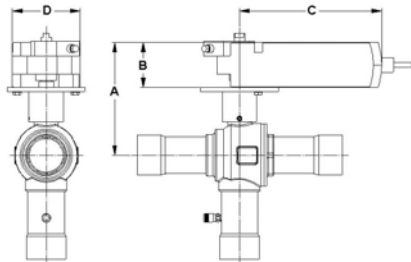

Tonnage calculations are based on the following conditions:
 Evaporator temperature: 40°F
 Vapor temperature exiting evaporator: 10°F superheated
 Liquid temperature entering evaporator: 100°F
 Hot gas temperature: 140°F
 Pressure drop across valve: 1 psig

Motor Specifications

Motor Series	Torque (in-lb)	Power Consumption (VA)	Running Time (seconds)
1	44	2.5	90
2	132	3.0	125
3	310	7	125
4 **	620	12	125

Part Number	Liquid Capacity (tons)					Suction Capacity (tons)					Hot Gas Capacity (tons)				
	R22	R134a	R404A/ R507	R407C	R410A	R22	R134a	R404A/ R507	R407C	R410A	R22	R134a	R404A/ R507	R407C	R410A
AW17861	19.0	17.7	12.2	18.13	17.8	2.7	2.1	2.2	2.52	3.1	3.9	3.2	3.2	4.05	4.5
AW17862	36.9	34.5	23.8	35.27	34.6	5.2	4.1	4.3	4.90	6.0	7.5	6.2	6.2	7.87	8.7
AW17863	58.0	54.1	37.4	55.40	54.4	8.1	6.4	6.8	7.69	9.5	11.8	9.7	9.7	12.37	13.7
AW17864	84.1	78.4	54.2	80.27	78.8	11.8	9.2	9.8	11.15	13.7	17.1	14.1	14.0	17.92	19.8
AW17865	165.3	154.3	106.5	157.86	154.9	23.2	18.1	19.4	21.92	27.0	33.7	27.7	27.6	35.24	38.9
AW17866	272.9	254.7	175.8	260.62	255.8	38.3	29.9	32.0	36.19	44.6	55.6	45.7	45.6	58.18	64.2
AW17867	348.7	325.3	224.6	332.95	326.8	49.0	38.2	40.8	46.23	57.0	71.1	58.4	58.3	74.33	82.1
AW17868	746.8	696.9	481.2	713.19	699.9	104.9	81.9	87.5	99.03	122.2	152.3	125.0	124.8	159.21	175.8
AW17869	1227.6	1145.5	791.0	1172.30	1150.5	172.4	134.6	143.8	162.78	200.8	250.3	205.5	205.2	261.71	289.0
AW17870	1693.7	1580.4	1091.3	1617.41	1587.4	237.9	185.8	198.4	224.58	277.0	345.3	283.5	283.1	361.08	398.7
AW17871	705.3	658.2	454.5	673.57	661.1	99.1	77.4	82.6	93.53	115.4	143.8	118.1	117.9	150.37	166.0
AW17872	439.3	409.9	283.0	419.50	411.7	61.7	48.2	51.5	58.25	71.9	89.6	73.5	73.4	93.65	103.4
AY17861	12.1	11.3	7.8	11.52	11.3	1.7	1.3	1.4	1.60	2.0	2.5	2.0	2.0	2.57	2.8
AY17862	14.2	13.2	9.1	13.54	13.3	2.0	1.6	1.7	1.88	2.3	2.9	2.4	2.4	3.02	3.3
AY17863	36.4	34.0	23.5	34.79	34.1	5.1	4.0	4.3	4.83	6.0	7.4	6.1	6.1	7.77	8.6
AY17864	33.3	31.1	21.5	31.84	31.2	4.7	3.7	3.9	4.42	5.5	6.8	5.6	5.6	7.11	7.8
AY17865	59.2	55.2	38.1	56.52	55.5	8.3	6.5	6.9	7.85	9.7	12.1	9.9	9.9	12.62	13.9
A 17810	95.1	88.7	61.3	90.81	89.1	13.4	10.4	11.1	12.61	15.6	19.4	15.9	15.9	20.27	22.4
A 17811	136.8	127.7	88.2	130.66	128.2	19.2	15.0	16.0	18.14	22.4	27.9	22.9	22.9	29.17	32.2
AY17868	233.7	218.0	150.6	223.14	219.0	32.8	25.6	27.4	30.98	38.2	47.6	39.1	39.1	49.81	55.0
AY17871	213.9	199.6	137.8	204.22	200.4	30.0	23.5	25.1	28.36	35.0	43.6	35.8	35.7	45.59	50.3
AY17872	178.2	166.2	114.8	170.13	167.0	25.0	19.5	20.9	23.62	29.1	36.3	29.8	29.8	37.98	41.9

CYCLEMASTER® Ball Valve

Accessories

Bracket Kits

Part Number	Valve Size	A		B		Screw Thread Size (C)	Wt	
		(in)	(mm)	(in)	(mm)		(lb)	(kg)
B 35531	1/4 - 5/8	2.28	58	0.17	4.4	M4 X .07	0.03	0.02
B 35532	3/4 - 7/8	2.84	72	0.17	4.4	M4 X .07	0.03	0.02
B 35533	1 1/8	3.07	78	0.17	4.4	M4 X .07	0.04	0.02
B 35534	1 3/8	3.62	92	0.25	6.4	M6 X 1.0	0.05	0.02
B 35535	1 5/8	3.94	100	0.25	6.4	M6 X 1.0	0.05	0.02
B 35536	2 1/8	4.80	122	0.25	6.4	M6 X 1.0	0.06	0.02

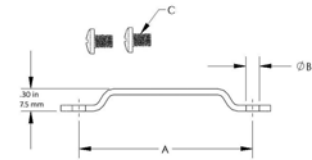

Insulation Cover

Insulation	Valve Size	A (in)	B (in)	C (in)	D (in)	E (in)	Thickness (in)	Wt(lb)
38RBVINS	3/8	5.50	3.00	0.63	2.50	1.19	0.50	0.10
12RBVINS	1/2	6.38	3.44	0.63	2.50	1.19	0.50	0.10
58RBVINS	5/8	6.38	3.44	0.63	2.50	1.38	0.50	0.10
34RBVINS	3/4	7.44	3.88	0.88	3.06	1.63	1.09	0.10
78RBVINS	7/8	7.44	3.88	0.88	3.06	1.63	1.09	0.10
118RBVINS	1 1/8	8.44	4.31	1.13	3.63	1.75	1.25	0.10
138RBVINS	1 3/8	10.00	5.00	1.25	3.94	2.06	1.35	0.10
158RBVINS	1 5/8	11.00	5.50	1.44	4.56	2.25	1.56	0.32
218RBVINS	2 1/8	12.00	6.06	1.88	5.38	2.44	1.75	0.10
258RBVINS	2 5/8	13.50	6.81	2.25	6.25	2.88	2.00	0.82
MSBVINS	Holes Offset	8.56	6.56	1.10	2.63	1.13	0.75	0.10
MSBVINSCEN	Holes Centered	8.56	4.28	1.10	2.63	1.13	0.75	0.02

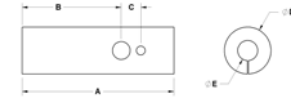
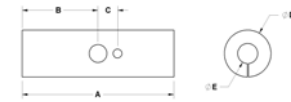

Retrofit Cap



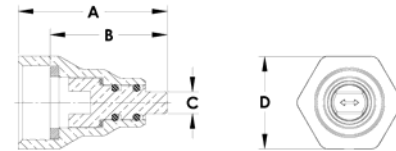









- Designed to replace existing caps on installed valves for the full range of CYCLEMASTER Ball Valve sizes 1/4" to 3 1/8"
- Large nut secures cap assembly to valve neck allowing center post to easily turn for on/off operation and clear visual identification
- Uses dual o-ring stem seals and base seal to assure positive isolation



Part Number	Valve Configuration	Valve Size in	A		B		C		D		Recommended Sealing Torque		Wt	
			in	mm	in	mm	in	mm	in	mm	ft-lb	N-m	lb	kg
A 18351	Straight	1/4 - 5/8	1.33	34	1.04	26	0.16	4	0.81	21	3 - 4	4 - 5	0.08	0.04
	3-Way	1/4 - 5/8												
A 18352	** Straight	3/4 - 1 1/8	1.50	38	1.18	30	0.22	6	0.94	24	5 - 6	7 - 8	0.12	0.05
	3-Way	3/4 - 7/8												
A 18353	*** Straight	1 3/8 - 1 5/8	1.92	49	1.59	40	0.31	8	1.13	29	13 - 15	18 - 20	0.22	0.10
	3-Way	1 1/8												
A 18354	Straight	2 1/8, 2 5/8 & 3 1/8" Red Port	2.57	65	1.97	50	0.38	10	1.63	41	40 - 45	54 - 61	0.57	0.26
	3-Way	1 3/8 - 2 1/8, 2 5/8 & 3 1/8" Red Port												
A 18355	* Straight	2 5/8 & 3 1/8 Full Port	2.66	68	2.10	53	0.38	10	1.88	48	45 - 50	61 - 68	0.84	0.38
	3-Way													

Valve sizes listed are based on current standard product offering. Confirm part number requirement based on thread size.

Component Parts Accessories

Stem Neck Thread Size	Connection Size (in)	Straight Body No.	3-Way Body No.	Motor Series	ABV Hub Kit	ABV Hub Kit w/ Enclosure	ABV Hub/ Motor Kit	Heater	Replacement Caps			
									1 Piece Plastic	1 Piece Brass	2 Piece Brass	Retrofit Brass
												
11/16"-16 UN	1/4	N 02351 F 35222	----	I	A 18389	A 18389-KIT1	A 18390	---	P 36723	A 17965	A 17842	A 18351
	3/8	F 36573 F 36700	F 35222									
	1/2	F 36700A										
	5/8											
13/16"-16 UN	3/4	N 02352 F 33957 F 35223 F 35427 F 35639 F 36701 F 36701A	F 35223	I	A 18391	A 18391-KIT1	A 18392	---	P 36762	A 17966	A 17843	A 18352
	7/8											
	1 1/8	F 36702A	---									
1"-16 UN	1 1/8	N 02353 F 33958 F 35224 F 35428 F 35640 F 36702	F 35224	II	A 18393	A 18393-KIT2	A 18394	A 18366	P 36763	A 17967	A 17844	A 18353
	1 3/8	F 35949 F 36703 F 36703A	---									
	1 5/8	F 36704A	---									
1 1/2"-16 UN	1 3/8	N 02354 F 35429 F 35641	F 35162	II	A 18368	A 18368-KIT2	A 18396	A 18366				
	1 5/8	N 02355 F 35430 F 35642 F 35950 F 36704	---									
		---	F 35160									
	2 1/8			III	A 18368	A 18368-KIT3	A 18395	A 18367	P 36764	A 17968	A 17845	A 18354
	2 5/8 Red. Port	F 35951 F 36451 F 36705 F 36705A	F 36595									
	3 1/8 Red. Port											
2 5/8 Full Port	F 36706A	---	IV	A 18764	A 18764-KIT4	A 18765	A 18367 (2)					
3 1/8 Full Port	F 36322A F 36707A	---										
3 5/8, 4 1/8												
1 3/4"-16 UN	2 1/8			III	A 18402	A 18402-KIT3	---	A 18367	P 36765	A 18399	A 17846	A 18355
	2 5/8 Red. Port	N 02356 F 35111	F 35161									
	3 1/8 Red. Port											
	2 5/8 Full Port	F 35755 F 36452 F 36706	---	IV	A 18400	A 18400-KIT4	A 18401	A 18367 (2)				
	3 1/8 Full Port	F 35952 F 36322 F 36707	---									

CYCLEMASTER® Ball Valve

Accessories

Actuators

Motor Series	I	II	III	IV
Standard Actuator	P 36408	P 36409	P 36410	P 36414 (2)
Actuator with Auxillary Switch	P 36417	P 36418	P 36419	P 36714 p 36889
Hub Seal Kits	A 18403 (1 Seal)	A 18404 (2 Seals)	A 18404 (2 Seals)	A 18404 (2 Seals)

Views shown without Hub Kit Bracket Assembly. Hub Seal Kits include seals ONLY.



* Note: Series IV motor assemblies require additional mounting hardware to join tandem motors.

Actuator Shaft Adapter Kits

Motor Series	I	II	III	IV
Shaft Adaptor Kit (1 per box)		P 37736	P 37735	P 37735
Position Indicator (10 per bag)	P 37732	P 37731	P 37730	P 37730
Shaft Adapter Clip (20 per bag)		P 37733	P 37734	P 37734
Shaft Insert (10 per bag)	P 37729			

Shaft Adapter kit includes Shaft Adapter (1), Clip (1), Position Indicator Set (1) and Screws (2).

Enclosures

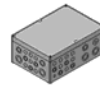
Motor Series	I	II	III	IV
Enclosure (L x W x H)	 7.1" x 5.1" x 3.0"	 10.0" x 7.1" x 4.0"	 14.2" x 10.0" x 6.0"	 14.2" x 10.0" x 6.0"

ABV Hub kit w/ Enclosure includes all the necessary accessories along with the hub kit to connect the enclosure to the hub.; Ambient Temperature (operation): -25°F to 125°F (-31°C to 51°C); Heater kit for lower temperature applications.

O Ring Kit for Actuator Hub Service

O-Ring Kits	Valve Size
A 18403	1/2 - 1 1/8
A 18404	1 3/8 - 3 1/8

Check Valves

Inline

Features:

- Design Pressure (DP) / Maximum abnormal pressure (MAP): 700 psig, 48 bar
- Continuous operating temperature (COT): -40°F/300°F, -40°C/149°C
- Pressure to open: < 1 psi
- Contact factory or visit website for compatibility with CFC, HCFC, HFC and HFO refrigerants and oils
- UL/cUL Recognized, Conforms to Pressure Equipment Directive 2014/68/EU
- Neoprene seat for positive isolation and pulsation dampening
- Enhanced internal design for maximum flow and minimum pressure drop

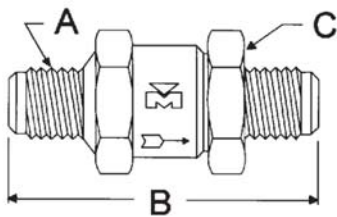

Flare to Flare

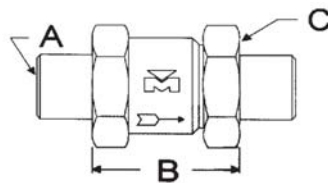

Solder to Solder

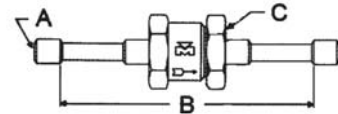

Solder to Solder, Extended Ends

Flare to Flare

Part Number	Size A		B		C		W/t	
	in	mm	in	mm	in	mm	lb	kg
A 15620	1/4	6	2.25	57	13/16 Hex	21 Hex	0.15	0.07
A 15621	3/8	10	2.40	61	13/16 Hex	21 Hex	0.20	0.09
A 15622	1/2	13	3.00	76	1 1/4 Oct	32 Oct	0.43	0.19
A 15623	5/8	17	3.20	81	1 1/4 Oct	32 Oct	0.51	0.23

Solder to Solder

Part Number	Size A		B		C		W/t		
	in	mm	in	mm	in	mm	lb	kg	
A 15628	*	1/4	6	1.14	29	13/16 Hex	21 Hex	0.13	0.06
A 15629	*	3/8	10	1.14	29	13/16 Hex	21 Hex	0.13	0.06
A 15630	*	1/2	13	1.44	37	1 1/4 Oct	32 Oct	0.37	0.17
A 15631	*	5/8	17	1.44	37	1 1/4 Oct	32 Oct	0.36	0.16
A 15632	**	1/4	6	4.40	112	13/16 Hex	21 Hex	0.16	0.07
A 15633	**	3/8	10	4.70	119	13/16 Hex	21 Hex	0.18	0.08
A 15634	**	1/2	13	4.90	124	1 1/4 Oct	32 Oct	0.43	0.20
A 15635	**	5/8	17	5.20	132	1 1/4 Oct	32 Oct	0.48	0.22

* Shipped loosely assembled

** Extended Ends

Check Valves

90° Angle



Features:

- Design Pressure (DP) / Maximum abnormal pressure (MAP): 700 psig, 48 bar
- Continuous operating temperature (COT): -40°F/300°F, -40°C/149°C
- Contact factory or visit website for compatibility with CFC, HCFC, HFC and HFO refrigerants and oils
- UL/cUL Recognized, Conforms to Pressure Equipment Directive 2014/68/EU
- 100% tested
- Forged brass body exceeds the most stringent quality standards in the industry
- Neoprene gasket

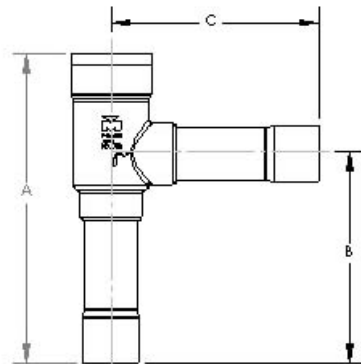

Part Number	Size (in)		Cv	Kv	A		B		C		Wt	
					in	mm	in	mm	in	mm	lb	kg
A 18383C	7/8	Male Inlet x Female Outlet	13.4	11.6	5.38	137	3.70	94	3.47	88	0.81	0.37
A 18565C	7/8	Male Inlet x Male Outlet	13.4	11.6	5.38	137	3.70	94	3.67	93	0.81	0.37
A 18566C	* 7/8	Female Inlet x Female Outlet	13.4	11.6	5.18	132	3.50	89	3.47	88	0.81	0.37
A 18659C	* 1 1/8	Female Inlet x Female Outlet	30.2	26.1	8.02	204	5.55	141	4.84	123	1.93	0.88
A 18660C	* 1 3/8	Female Inlet x Female Outlet	37.0	32.0	8.02	204	5.55	141	4.84	123	1.98	0.90

Standard valve includes 2 lb spring

* Prefixed AH for valve with 4.3 lb spring

Check Valves

Magnetic

Features:

- Design Pressure (DP) / Maximum abnormal pressure (MAP): Charted below
- Continuous operating temperature (COT): -40°F/300°F, -40°C/149°C
- Contact factory or visit website for compatibility with CFC, HCFC, HFC and HFO refrigerants and oils
- UL/cUL Recognized, Conforms to Pressure Equipment Directive 2014/68/EU
- Built-in 30 mesh stainless steel screen
- Internal components installed with DuraForm Technology
- Mechanically formed solder cup stops for easy installation
- Flexible for installation in vertical or horizontal position
- Hermetically formed solid copper body assures zero leak potential

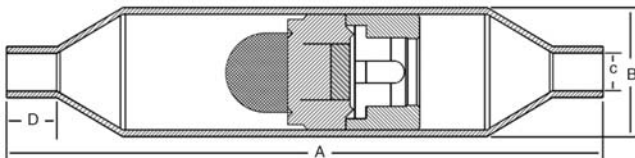

Part Number	Model	Size C (in)		A		B		D		MAP		Wt	
				in	mm	in	mm	in	mm	psig	bar	lb	kg
A 17934	CMV-4S	1/4	6	4.02	102	0.88	22	0.34	9	800	55	0.20	0.09
A 17935	CMV-6S	3/8	10	4.02	102	0.88	22	0.34	9	800	55	0.20	0.09
A 17936	CMV-8S	1/2	13	5.18	131	1.13	29	0.41	10	800	55	0.38	0.17
A 17937	CMV-10S	5/8	17	5.18	131	1.13	29	0.53	13	800	55	0.34	0.16
A 17938	CMV-12S	3/4	19	7.04	179	1.63	41	0.65	17	800	55	0.87	0.40
A 17939	CMV-14S	7/8	22	7.04	179	1.63	41	0.78	20	800	55	0.90	0.41
A 17940	CMV-18S	1 1/8	29	8.43	214	2.13	54	0.94	24	800	55	1.61	0.73
A 17941	CMV-22S	1 3/8	35	9.41	239	2.63	67	1.00	25	800	55	2.74	1.24
A 17942	CMV-26S	1 5/8	41	10.55	268	3.13	79	1.12	28	800	55	3.91	1.77
A 17943	CMV-34S	2 1/8	54	12.06	306	3.63	92	1.37	35	775	53	6.00	2.72
A 17944	CMV-42S	2 5/8	67	13.05	331	4.13	105	1.50	38	775	53	7.00	3.18
A 17981	CMV-50S	3 1/8	79	13.05	331	4.13	105	1.69	43	700	48	7.43	3.37

Check Valves

Piston



Features:

- Continuous operating temperature (COT): -40°F/300°F, -40°C/149°C
- Contact factory or visit website for compatibility with CFC, HCFC, HFC and HFO refrigerants and oils
- UL/cUL Recognized, Conforms to Pressure Equipment Directive 2014/68/EU
- Enhanced internal design for maximum flow and minimum pressure drop
- Design Pressure (DP) / Maximum abnormal pressure (MAP): Charted below
- 1/4" - 1/2" sized valves are designed for use with R744 (CO₂)
- 5/8" - 7/8" sized valves are designed for use with R744 in cascading systems or secondary loops where design pressures are below the R744 critical pressure of 1058 psi

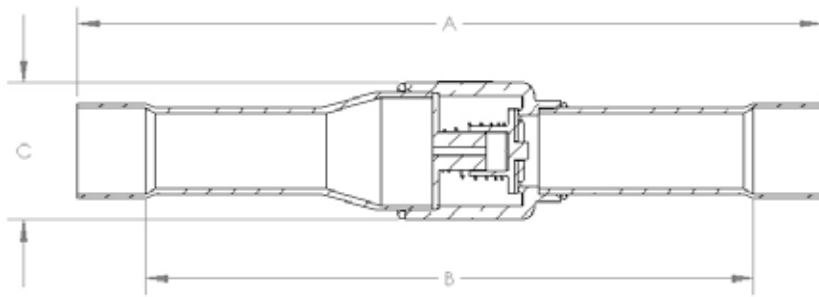

Part Number	Size ODS		Cv	Kv	ΔP psi	A		B		C		Wt		MAP	
	in	mm				in	mm	in	mm	lb	kg				
A 18720	1/4	6	0.70	0.61	1	3.62	92	3.00	76	0.71	18	0.11	0.05	1305	
A 18721	3/8	10	1.40	1.21	1	4.29	109	3.60	91	0.71	18	0.12	0.05	1305	
A 18722	1/2	13	2.71	2.34	.75	5.15	131	4.28	109	0.85	22	0.16	0.07	1305	
A 18723	5/8	17	4.10	3.55	.75	5.43	138	4.43	113	1.00	25	0.22	0.10	1000	
A 18838	3/4	19	8.76	7.58	.75	7.01	178	5.86	149	1.34	34	0.43	0.19	1000	
A 18724	7/8	22	9.19	7.95	.75	6.50	165	5.25	133	1.34	34	0.42	0.19	1000	
AH18720	*	1/4	6	0.70	0.61	4.4	3.62	92	3.00	76	0.71	18	0.12	0.05	1305
AH18721	*	3/8	10	1.40	1.21	4.4	4.29	109	3.60	91	0.71	18	0.12	0.05	1305
AH18722	*	1/2	13	2.71	2.34	4.4	5.15	131	4.28	109	0.85	22	0.17	0.07	1305
AH18723	*	5/8	17	4.10	3.55	4.4	5.43	138	4.43	113	1.00	0.29	0.13	1000	
AH18838	*	3/4	19	8.76	7.58	4.4	7.01	178	5.86	149	1.34	0.43	0.19	1000	
AH18724	*	7/8	22	9.19	7.95	4.4	6.50	165	5.25	133	1.34	0.43	0.19	1000	

Prefixed AH for valve with 4.4 lb spring

Standard valve includes 1 lb spring

* Prefixed AH for valves with higher ΔP

ΔP Minimum pressure at which valve fully opens.

Check Valves

Four-Bolt

Features:

- Design Pressure (DP) / Maximum abnormal pressure (MAP): 700 psig, 48 bar
- Continuous operating temperature (COT): -40°F/300°F, -40°C/149°C
- Contact factory or visit website for compatibility with CFC, HCFC, HFC and HFO refrigerants and oils
- UL/cUL Recognized, Conforms to Pressure Equipment Directive 2014/68/EU
- 100% tested
- Design features easy removal and reassembly of internal components
- Forged brass body exceeds the most stringent quality standards in the industry
- Horizontal or vertical installation (not to be installed with bonnet facing down)
- "Y" type design provides minimal pressure drop and increased flow capacity
- Non-asbestos gasket material ensures seal integrity, while a heat-stabilized PTFE seat provides seal across wide temperature ranges.
- Back pressure shutoff at low pressure differentials

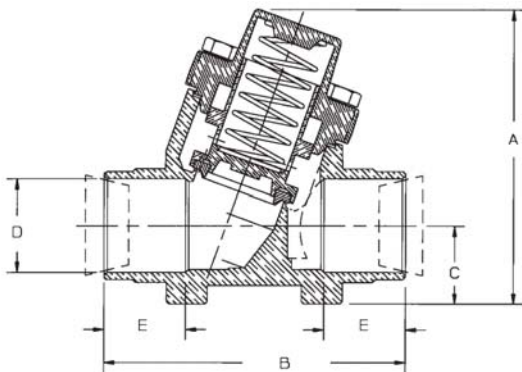

Part Number	Size D		Cv	Kv	A		B		C		E		Pressure to Open	Rec Bolt Torques				Replacement Components				Wt	
	in	mm			in	mm	in	mm	in	mm	in	mm		in	mm	psi	bar	ft-lb	N-m	Kit **	10 lb Spring	20 lb Spring	Gasket
B 34235	*	7/8	22	9.00	8	3.55	90	3.68	93	0.94	24	0.94	24	<1	<.07	8 - 15	11 - 20	A 17986	P 35656	P 35859	P 35708	2.39	1.08
B 34236	*	1 1/8	29	12.00	10	3.55	90	3.68	93	0.94	24	1.00	25	<1	<.07	8 - 15	11 - 20	A 17986	P 35656	P 35859	P 35708	2.29	1.04
B 34237	*	1 3/8	35	19.90	17	4.53	115	4.75	121	1.25	32	1.06	27	<1	<.07	10 - 20	14 - 27	A 17987	P 35657	P 36305	P 35691	5.14	2.33
B 34238	*	1 5/8	41	21.90	19	4.53	115	4.75	121	1.25	32	1.06	27	<1	<.07	10 - 20	14 - 27	A 17987	P 35657	P 36305	P 35691	5.20	2.36
B 34239	*	2 1/8	54	38.90	34	5.84	148	6.37	162	1.70	43	1.50	38	<1	<.07	10 - 20	14 - 27	A 17988	P 36544		P 35721	12.23	5.55
B 34240	*	2 5/8	67	86.10	74	8.00	203	8.88	226	2.00	51	1.90	48	<1	<.07	15 - 25	20 - 34	A 18050			P 36041	27.67	12.55
B 34241	*	3 1/8	79			8.00	203	8.88	226	2.00	51	1.90	48	<1	<.07	15 - 25	20 - 34	A 18050			P 36041	26.80	12.16

* Includes standard spring

** Replacement kit includes seat holder subassembly, cover gasket and 2 lb spring

Brass Compressor Valves

Double Port, 45° Flare



Features:

- Design Pressure (DP) / Maximum abnormal pressure (MAP): 700 psig, 48 bar
- Continuous operating temperature (COT): -40°F/300°F, -40°C/149°C
- Contact factory or visit website for compatibility with CFC, HCFC, HFC and HFO refrigerants and oils
- UL/cUL Recognized, Conforms to Pressure Equipment Directive 2014/68/EU
- 100% tested
- Asbestos-free valve packing
- Valve openings designed for maximum flow and minimum pressure drop

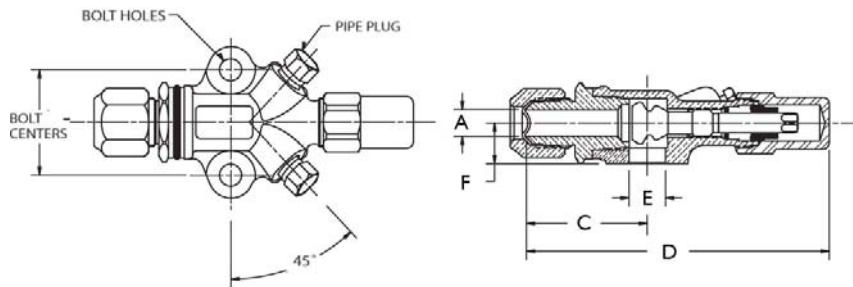

Valve Part Number	Valve Kit Part Number	A		C		D		E		F		Bolt Hole Diameter		Pipe Plug Size		Flange Thickness		Seat Position	Valve Wt		Valve Kit Wt		
		in	mm	in	mm	in	mm	in	mm	in	mm	in	mm	in	mm	in	mm		lb	kg	lb	kg	
A 16302	A 17518	3/8	10	1.73	44	4.45	113	0.56	14	0.62	16	1 5/8	41	.34	9	1/8	7/8	22	Mid	1.20	0.54	1.24	0.56
A 16303	A 17519	1/2	13	1.86	47	4.67	119	0.56	14	0.62	16	1 5/8	41	.34	9	1/8	7/8	22	Mid	1.17	0.53	1.17	0.53
A 16304	A 17520	5/8	17	1.99	51	4.80	122	0.56	14	0.62	16	1 5/8	41	.34	9	1/8	7/8	22	Mid	1.23	0.56	1.27	0.58

Torque To Seal

Front Seat		Back Seat		Pack Gland		Pipe Plug	Plastic Cap	Brass Cap		Steel Cap	
(ft-lb)	(N-m):	(ft-lb)	(N-m):	(ft-lb)	(N-m):			(ft-lb)	(N-m)	(ft-lb)	(N-m)
14 - 18	19 - 24	14 - 18	19 - 24	8 - 12	11 - 16	2 - 3 Threads Exposed	NA	20 - 30	27 - 41	3 - 5	4 - 7

References

Valve Part Number	Valve Kit Part Number *	Body Number	Standard Seal Cap		Replacement Seal Cap			Replacement Kit**	Valve Kit *	Manufacturer Reference to Valve Kit Part Number	
			Material	Seal Cap	Plastic	Brass***	Steel			Carrier	Copeland
A 16302	A 17518	A 09464	Steel	A 04566	P 34627	A 16474	A 04566	A 17420	A 17518	998-0510-15	
A 16303	A 17519	A 09464	Steel	A 04566	P 34627	A 16474	A 04566	A 17420	A 17519	998-0510-16	
A 16304	A 17520	A 09464	Steel	A 04566	P 34627	A 16474	A 04566	A 17420	A 17520	998-0510-17	

- * Valve kit includes valve, gasket and bolts
- ** Replacement kit contains components to pack stem (pack gland, packing and pack washer)
- *** Cap and cap gasket kit
- **** Seal cap and o-ring kit
- ***** O-ring included

Brass Compressor Valves

Double Port, Solder

Features:

- Design Pressure (DP) / Maximum abnormal pressure (MAP): 700 psig, 48 bar
- Continuous operating temperature (COT): -40°F/300°F, -40°C/149°C
- Contact factory or visit website for compatibility with CFC, HCFC, HFC and HFO refrigerants and oils
- UL/cUL Recognized, Conforms to Pressure Equipment Directive 2014/68/EU
- 100% tested
- Asbestos-free valve packing
- Valve openings designed for maximum flow and minimum pressure drop

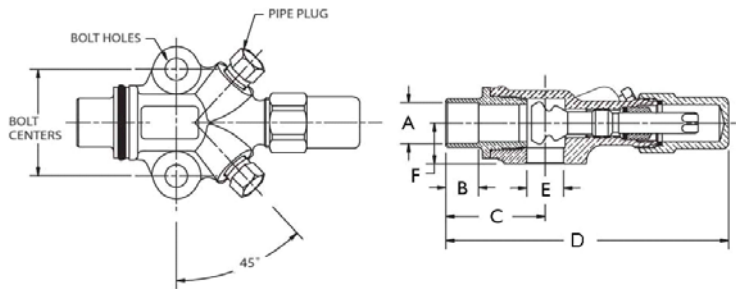

Valve Part	Valve Kit Part Number	A		B		C		D		E		F		Bolt Centers in mm	Bolt Hole Diameter in mm	Pipe Plug Size in	Flange Thickness in mm	Seat Position	Valve Wt		Valve Kit Wt				
		in	mm	in	mm	in	mm	in	mm	in	mm	in	mm						lb	kg	lb	kg			
A 16307	A 17510	3/8	10	0.31	8	1.27	32	4.07	103	0.56	14	0.62	16	15/8	41	.34	9	1/8	7/8	22	Front	0.69	0.31	0.73	0.33
A 16308	A 17511	1/2	13	0.38	10	1.40	36	4.20	107	0.56	14	0.62	16	15/8	41	.34	9	1/8	7/8	22	Front	0.86	0.39	0.90	0.41
A 16309	A 17512	5/8	17	0.50	13	1.52	39	4.32	110	0.56	14	0.62	16	15/8	41	.34	9	1/8	7/8	22	Front	0.88	0.40	0.92	0.42
A 16309	A 17531	5/8	17	0.50	13	1.52	39	4.32	110	0.56	14	0.62	16	15/8	41	.34	9	1/8	7/8	22	Front	0.88	0.40	0.93	0.42

Torque To Seal

Front Seat		Back Seat		Pack Gland		Pipe Plug	Plastic Cap	Brass Cap		Steel Cap	
(ft-lb)	(N-m)	(ft-lb)	(N-m)	(ft-lb)	(N-m)			(ft-lb)	(N-m)	(ft-lb)	(N-m)
14 - 18	19 - 24	14 - 18	19 - 24	8 - 12	11 - 16	2 - 3 Threads Exposed	NA	20 - 30	27 - 41	3 - 5	4 - 7

References

Valve Part Number	Valve Kit Part Number *	Body Number	Standard Seal Cap			Replacement Seal Cap			Replacement Kit**	Valve Kit *	Manufacturer Cross Reference to Valve Kit Part Number	
			Material	Seal Cap	Plastic	Brass***	Steel	Carrier			Copeland	
A 16307	A 17510	A 09464	Steel	A 04566	P 34627	A 16474	A 04566	A 17420	A 17510		998-0510-04	
A 16308	A 17511	A 09464	Steel	A 04566	P 34627	A 16474	A 04566	A 17420	A 17511		998-0510-05	
A 16309	A 17512	A 09464	Steel	A 04566	P 34627	A 16474	A 04566	A 17420	A 17512		998-0510-06	
A 16309	A 17531	A 09464	Steel	A 04566	P 34627	A 16474	A 04566	A 17420	A 17531			

- # Plastic Bag
- * Valve kit includes valve, gasket and bolts
- ** Replacement kit contains components to pack stem (pack gland, packing and pack washer)
- *** Cap and cap gasket kit
- **** Seal cap and o-ring kit
- ***** O-ring included

Brass Compressor Valves

Straight Port, 45° Flare



Features:

- Design Pressure (DP) / Maximum abnormal pressure (MAP): 700 psig, 48 bar
- Continuous operating temperature (COT): -40°F/300°F, -40°C/149°C
- Contact factory or visit website for compatibility with CFC, HCFC, HFC and HFO refrigerants and oils
- UL/cUL Recognized, Conforms to Pressure Equipment Directive 2014/68/EU
- 100% tested
- Asbestos-free valve packing
- Valve openings designed for maximum flow and minimum pressure drop

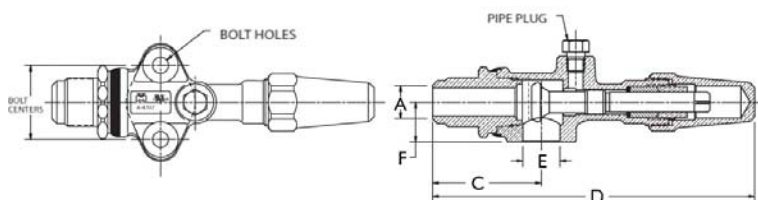

Valve Part Number	A		B		C		D		E		F		Bolt Centers		Bolt Hole Diameter		Pipe Plug Size	Flange Thickness		Seat Position	Valve Wt	
	in	mm	in	mm	in	mm	in	mm	in	mm	in	mm	in	mm	in	mm	in	in	mm	Mid	lb	kg
A 13166	3/4	19			2.37	60	7.05	179	0.81	21	0.85	22	1 5/8	41	.34	9	1/8	1 1/4	32	Mid	1.78	0.81

Torque To Seal

Front Seat		Back Seat		Pack Gland		Pipe Plug	Plastic Cap	Brass Cap		Steel Cap	
(ft-lb)	(N-m)	(ft-lb)	(N-m)	(ft-lb)	(N-m)			(ft-lb)	(N-m)	(ft-lb)	(N-m)
22 - 40	30 - 54	25 - 45	34 - 61	15 - 25	20 - 34	2 - 3 Threads Exposed	Hand Tight	40 - 50	54 - 68	NA	NA

References

Valve Part Number	Body Number	Material	Standard Seal Cap			Replacement Seal Cap			Replacement Kit**	Valve Kit *	Manufacturer Reference	
			Seal Cap	Gasket	O-ring Kit****	Plastic	Brass****	Steel			Carrier	Copeland
A 13166	A 04707	Brass	A 04775	A 04710	A 15099		A 15099		A 17419			

- * Valve kit includes valve, gasket and bolts
- ** Replacement kit contains components to pack stem (pack gland, packing and pack washer)
- *** Cap and cap gasket kit
- **** Seal cap and o-ring kit
- ***** O-ring included

Brass Compressor Valves

Straight Port, Solder

Features:

- Design Pressure (DP) / Maximum abnormal pressure (MAP): 700 psig, 48 bar
- Continuous operating temperature (COT): -40°F/300°F, -40°C/149°C
- Contact factory or visit website for compatibility with CFC, HCFC, HFC and HFO refrigerants and oils
- UL/cUL Recognized, Conforms to Pressure Equipment Directive 2014/68/EU
- 100% tested
- Asbestos-free valve packing
- Valve openings designed for maximum flow and minimum pressure drop

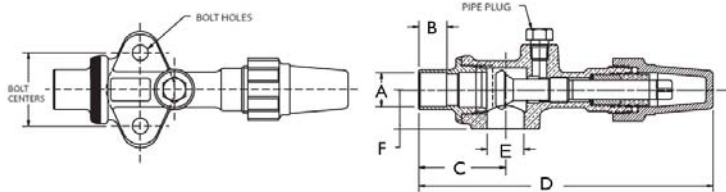

Valve Part Number	Kit Part Number	A	B	C	D	E	F	Bolt Centers	Bolt Hole Diameter	Pipe Plug Size	Flange Thickness	Seat Position	Valve Wt	Kit Wt											
		in	mm	in	mm	in	mm	in	mm	in	mm	in	lb	kg											
A 16310		3/4	19	0.62	16	1.91	49	6.49	165	0.81	21	0.88	22	15/8	41	.34	9	1/8	1 21/64	34	Front	1.64	0.74		
A 16311	A 17515	7/8	22	0.76	19	1.97	50	6.55	166	0.81	21	0.88	22	15/8	41	.34	9	1/8	1 21/64	34	Front	1.63	0.74	1.55	0.70
B 32197	A 17529	7/8	22	0.76	19	1.97	50	6.47	164	0.81	21	0.88	22	1 3/4	44	.34	9	1/8	1 21/64	34	Mid	1.42	0.64	1.69	0.77
A 15500		1 1/8	29	0.90	23	2.06	52	6.64	169	0.81	21	0.88	22	1 5/8	41	.34	9	1/8	1 21/64	34	Back	1.43	0.65		
A 16312	A 17516	1 1/8	29	0.90	23	2.06	52	6.64	169	0.81	21	0.88	22	1 5/8	41	.34	9	1/8	1 21/64	34	Front	1.66	0.75	1.55	0.70

Torque To Seal

Front Seat	Back Seat	Pack Gland	Pipe Plug	Plastic Cap	Brass Cap	Steel Cap					
(ft-lb)	(N-m):	(ft-lb)	(N-m):	(ft-lb)	(N-m):	(ft-lb)	(N-m)				
22 - 40	30 - 54	25 - 45	34 - 61	15 - 25	20 - 34	2 - 3 Threads Exposed	Hand Tight	40 - 50	54 - 68	NA	NA

References

Valve Part Number	Body Number	Standard Seal Cap			Replacement Seal Cap			Replacement Kit**	Valve Kit *	Manufacturer Reference	
		Material	Seal Cap *****	Kit	Plastic*****	Brass****	Steel			Carrier	Copeland
A 16310	A 04707	Plastic	P 34632	P 35915	P 34632	A 15099	A 17419				
A 16311	A 04707	Plastic	P 34632	P 35915	P 34632	A 15099	A 17419	A 17515			998-0510-12
B 32197	A 04715	Plastic	P 34632	P 35915	P 34632	A 15099	A 17419	A 17529	06DA660-062		
A 15500	A 04707	Plastic	P 34632	P 35915	P 34632	A 15099	A 17419				
A 16312	A 04707	Plastic	P 34632	P 35915	P 34632	A 15099	A 17419	A 17516			998-0510-13

* Valve kit includes valve, gasket and bolts

** Replacement kit contains components to pack stem (pack gland, packing and pack washer)

*** Cap and cap gasket kit

**** Seal cap and o-ring kit

***** O-ring included

Brass Compressor Valves

Flange Union, Solder



Features:

- Design Pressure (DP) / Maximum abnormal pressure (MAP): 700 psig, 48 bar
- Continuous operating temperature (COT): -40°F/300°F, -40°C/149°C
- Contact factory or visit website for compatibility with CFC, HCFC, HFC and HFO refrigerants and oils
- UL/cUL Recognized, Conforms to Pressure Equipment Directive 2014/68/EU
- 100% tested
- Asbestos-free valve packing
- Valve openings designed for maximum flow and minimum pressure drop

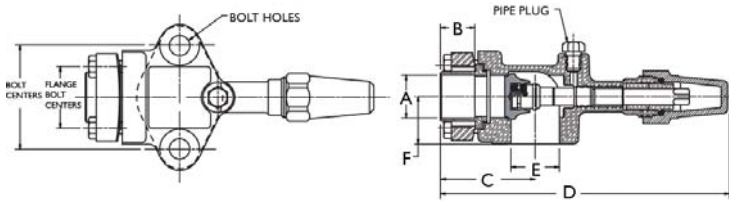

Valve Part Number	Valve Kit Part Number	A		B		C		D		E		F		Bolt Centers	Bolt Hole Diameter	Pipe Plug Size	Flange Thickness	Seat Position	Valve Wt	Valve Kit Wt					
		in	mm	in	mm	in	mm	in	mm	in	mm	in	mm	in	mm	in	mm	lb	kg	lb	kg				
A 16313		3/4	19	0.62	16	2.31	59	7.33	186	1.25	32	1.25	32	2 3/4	70	.531	13	1/8	1	25	Front	3.93	1.78		
A 16314	A 17527	7/8	22	0.75	19	2.31	59	7.33	186	1.25	32	1.25	32	2 3/4	70	.531	13	1/8	1	25	Front	3.90	1.77	4.05	1.84
A 16315	A 17525	1 1/8	29	0.91	23	2.47	63	7.49	190	1.25	32	1.25	32	2 3/4	70	.531	13	1/8	1	25	Front	3.66	1.66	4.03	1.83
A 16316	A 17526	1 3/8	35	0.97	25	2.47	63	7.49	190	1.25	32	1.25	32	2 3/4	70	.531	13	1/8	1	25	Front	3.65	1.66	3.80	1.72

Torque To Seal

Front Seat		Back Seat		Pack Gland		Pipe Plug	Plastic Cap	Brass Cap		Steel Cap	
(ft-lb)	(N-m)	(ft-lb)	(N-m)	(ft-lb)	(N-m)			(ft-lb)	(N-m)	(ft-lb)	(N-m)
30 - 40	41 - 54	22 - 45	30 - 61	15 - 25	20 - 34	2 - 3 Threads Exposed	Hand Tight	40 - 50	54 - 68	NA	NA

References

Valve Part Number	Valve Kit Part Number *	Body Number	Standard Seal Cap		Replacement Seal Cap			Replacement Kit**	Valve Kit *	Manufacturer Reference to Valve Kit Part Number	
			Material	Seal Cap *****	Kit	Plastic *****	Brass***			Steel	Carrier
A 16313	A 16313	A 03416	Plastic	P 34632	P 35915	P 34632	A 15099	A 17419			
A 16314	A 16314	A 03416	Plastic	P 34632	P 35915	P 34632	A 15099	A 17419	A 17527		998-0510-10
A 16315	A 16315	A 03416	Plastic	P 34632	P 35915	P 34632	A 15099	A 17419	A 17525		998-0510-09
A 16316	A 16316	A 03416	Plastic	P 34632	P 35915	P 34632	A 15099	A 17419	A 17526		998-0510-11

* Valve kit includes valve, gasket and bolts

** Replacement kit contains components to pack stem (pack gland, packing and pack washer)

*** Cap and cap gasket kit

**** Seal cap and o-ring kit

***** O-ring included

Brass Compressor Valves

Four-Bolt Mounting, Solder

Features:

- Design Pressure (DP) / Maximum abnormal pressure (MAP): 700 psig, 48 bar
- Continuous operating temperature (COT): -40°F/300°F, -40°C/149°C
- Contact factory or visit website for compatibility with CFC, HCFC, HFC and HFO refrigerants and oils
- UL/cUL Recognized, Conforms to Pressure Equipment Directive 2014/68/EU
- 100% tested
- Asbestos-free valve packing
- Valve openings designed for maximum flow and minimum pressure drop
- Flat Gasket Surface

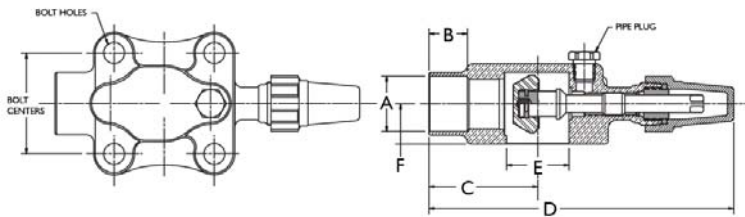

Valve Part Number	Valve Kit Part Number*	A		B		C		D		E		F		Bolt Centers		Bolt Hole Diameter		Pipe Plug Size in	Flange Thickness		Seat Position	Valve Wt		Valve Kit Wt	
		in	mm	in	mm	in	mm	in	mm	in	mm	in	mm	in	mm	in	mm		in	mm		lb	kg	lb	kg
B 32807	A 17532	1 1/8	29	0.90	23	2.72	69	7.61	193	1.56	40	1.00	25	2.5	64	.53	13	1/4		Mid	4.00	1.81	4.47	2.03	
B 32808	A 17533	1 3/8	35	0.96	24	2.72	69	7.61	193	1.56	40	1.00	25	2.5	64	.53	13	1/4		Mid	3.98	1.80	4.67	2.12	
B 32930	A 17534	1 5/8	41	1.10	28	2.88	73	7.89	200	1.81	46	1.03	26	2.5	64	.53	13	1/4		Mid	4.13	1.87	4.67	2.12	

Torque To Seal

Front Seat		Back Seat		Pack Gland		Pipe Plug		Plastic Cap		Brass Cap		Steel Cap	
(ft-lb)	(N-m):	(ft-lb)	(N-m):	(ft-lb)	(N-m):	(ft-lb)	(N-m):			(ft-lb)	(N-m)	(ft-lb)	(N-m)
22 - 40	30 - 54	25 - 45	34 - 61	10 - 15	14 - 20	2 - 3 Threads Exposed		Hand Tight		40 - 50	54 - 68	NA	NA

References

Valve Part Number	Valve Kit Part Number*	Body Number	Material	Standard Seal Cap		Replacement Seal Cap			Replacement Kit**	Valve Kit*	Manufacturer Reference to Valve Kit Part Number	
				Seal Cap ****	Kit	Plastic****	Brass****	Steel			Carrier	Copeland
B 32807	B 32807	F 27950	Plastic	P 34632	P 35915	P 34632	A 15099		A 17418	A 17532	06DA660-063	
B 32808	B 32808	F 27955	Plastic	P 34632	P 35915	P 34632	A 15099		A 17418	A 17533	06DA660-065	
B 32930	B 32930	F 29201	Plastic	P 34632	P 35915	P 34632	A 15099		A 17418	A 17534	06DA660-090	

* Valve kit includes valve, gasket and bolts

** Replacement kit contains components to pack stem (pack gland, packing and pack washer)

*** Cap and cap gasket kit

**** Seal cap and o-ring kit

***** O-ring included

Brass Compressor Valves

Four-Bolt Mounting, Access Port



Features:

- Design Pressure (DP) / Maximum abnormal pressure (MAP): 700 psig, 48 bar
- Continuous operating temperature (COT): -40°F/300°F, -40°C/149°C
- Contact factory or visit website for compatibility with CFC, HCFC, HFC and HFO refrigerants and oils
- UL/cUL Recognized, Conforms to Pressure Equipment Directive 2014/68/EU
- 100% tested
- Asbestos-free valve packing
- Valve openings designed for maximum flow and minimum pressure drop

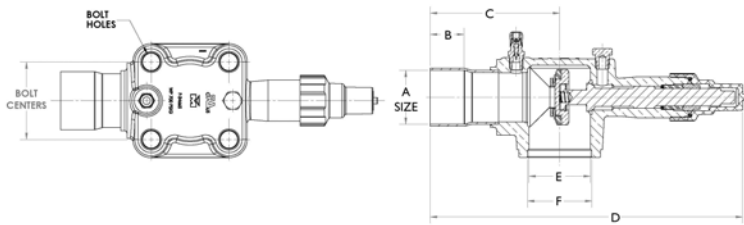

Valve Part Number	Valve Kit Part Number	A		B		C		D		E		F		Bolt Centers		Bolt Hole Diameter		Pipe Plug Size	Access Port	Seat Position	Valve Wt		Valve Kit Wt	
		in	mm	in	mm	in	mm	in	mm	in	mm	in	mm	in	mm	in	mm	in	in	in	lb	kg	lb	kg
A 17495		2 1/8	54	1.34	34	5.09	129	12.31	313	2.42	61	2.53	64	3.06	78	.69	17	1/4	0.25	Mid	11.84	5.37		

Torque To Seal

Front Seat		Back Seat		Pack Gland		Pipe Plug	Plastic Cap	Brass Cap	Steel Cap		
(ft-lb)	(N-m)	(ft-lb)	(N-m)	(ft-lb)	(N-m)			(ft-lb)	(N-m)	(ft-lb)	(N-m)
45 - 65	61 - 88	45 - 65	61 - 88	35 - 45		240 - 300	Hand Tight				

References

Valve Part Number	Valve Kit Part Number*	Body Number	Standard Seal Cap			Replacement Seal Cap			Replacement Kit**	Valve Kit *	Manufacturer Reference to Valve Kit Part Number	
			Material	Seal Cap *****	Kit	Plastic*****	Brass*****	Steel			Carrier	Copeland
A 17495	A 17495	F 34665	Plastic	N 02849	A 17668	A 17668	A 15099		A 17422			

** Replacement kit contains components to pack s

***** Seal cap and o-ring kit

***** O-ring included

Packed Line Valves, Angle Backseating

Features:

- Design Pressure (DP) / Maximum abnormal pressure (MAP): 700 psig, 48 bar
- Continuous operating temperature (COT): -40°F/300°F, -40°C/149°C
- Contact factory or visit website for compatibility with CFC, HCFC, HFC and HFO refrigerants and oils
- UL/cUL Recognized, Conforms to Pressure Equipment Directive 2014/68/EU
- Forged brass body
- Corrosion resistant stem suitable for refrigerants and other industrial fluids

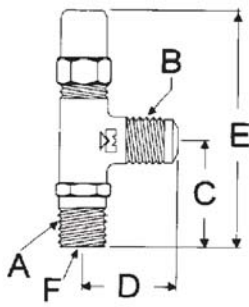

NPTFE Inlet to Flare

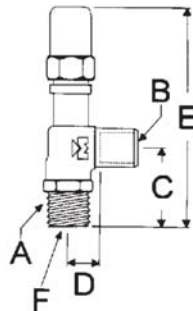

NPTFE Inlet to Solder

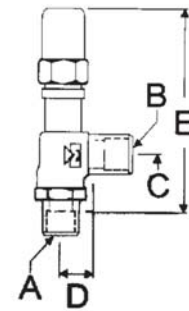

Solder to Solder

NPTFE Inlet to Flare

Part Number	NPTFE A		Flare B		C		D		E		Counterbore Dim F		Standard Cap		Replacement Seal Cap			Wt			
	in	mm	in	mm	in	mm	in	mm	in	mm	in	mm	Material	Seal Cap	Brass	Plastic	Steel	lb	kg		
A 13183	1/2		5/8		1.81	46	1.50	38	4.64	118	.504	12.80	.375	9.53	Steel	A 04566	A 16474	P 34627	A 04566	0.58	0.26
A 13220	1/2		1/2		1.81	46	1.31	33	4.11	104	.504	12.80	.375	9.53	Steel	A 04566	A 16474	P 34627	A 04566	0.55	0.25

NPTFE Inlet to Solder

Part Number	NPTFE A		Solder B		C		D		E		Counterbore Dim F		Standard Cap		Replacement Seal Cap			Wt			
	in	mm	in	mm	in	mm	in	mm	in	mm	in	mm	Material	Seal Cap	Brass	Plastic	Steel	lb	kg		
A 13977	1/2	13	1/2	13	1.81	46	1.00	25	4.11	104	.504	12.80	.375	9.53	Steel	A 04566	A 16474	P 34627	A 04566	0.45	0.20
A 13978	1/2	13	5/8	17	1.80	46	1.00	25	4.70	119	.504	12.80	.375	9.53	Steel	A 04566	A 16474	P 34627	A 04566	0.55	0.25
A 13979	3/4	19	7/8	22	2.10	53	1.00	25	6.02	153	.754	19.15	.625	15.88	Plastic	P 34632	A 16474	P 34627	A 04566	1.02	0.46

Solder to Solder

Part Number	A		B		C		D		E		Standard Cap		Replacement Seal Cap			Packing Kit	Wt		
	in	mm	in	mm	in	mm	in	mm	in	mm	Material	Seal Cap	Brass	Plastic	Steel		lb	kg	
A 17506	5/8	17	5/8	17	1.40	36	1.00	25	4.20	107		Steel	A 04566	A 16474	P 34627	A 04566	A 17420	0.66	0.30

Packed Line Valves, Angle

Non-Backseating



Features:

- Design Pressure (DP) / Maximum abnormal pressure (MAP): 700 psig, 48 bar
- Continuous operating temperature (COT): -40°F/300°F, -40°C/149°C
- Contact factory or visit website for compatibility with CFC, HCFC, HFC and HFO refrigerants and oils
- UL/cUL Recognized, Conforms to Pressure Equipment Directive 2014/68/EU
- Forged brass body
- Corrosion resistant stem suitable for refrigerants and other industrial fluids

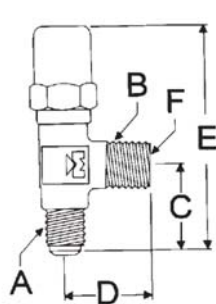

Flare to NPTFE

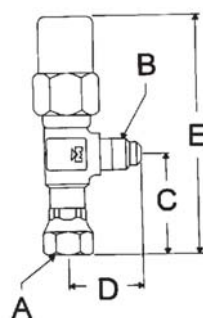

Internal Swivel Fl x Fl

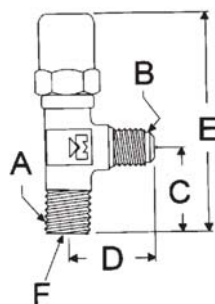

NPTFE Inlet to Flare

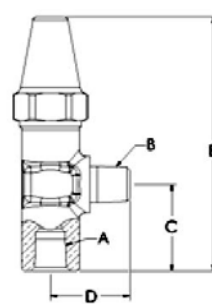

NPTFE x NPTFI

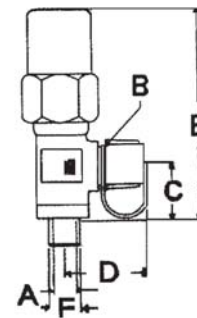

Solder to Flare

Flare to NPTFE

Part Number	Flare A in	NPTFE B		C in	D		E		Counterbore Dim F				Standard Cap		Replacement Seal Cap			Wt		
		in	mm		in	mm	in	mm	in	mm	in	mm	Material	Seal Cap	Brass	Plastic	Steel	lb	kg	
A 15073	#	1/4	1/4	0.94	24	1.00	25	2.96	75	.254	6.45	.31	7.87	Steel	A 04566	A 16474	P 34627	A 04566	0.43	0.19

Torque			
Pack Gland		Seal Cap	
ft-lb	N-m	ft-lb	N-m
8 - 12	11 - 16	6 - 10	8 - 14

Internal Swivel Flare to Flare

Part Number	Flare A in	Flare B in	C in	D in	E in	Torque				Standard Cap		Replacement Seal Cap			Wt					
						Pack Gland		Seal Cap		Material	Seal Cap	Brass	Plastic	Steel	lb	kg				
						ft-lb	N-m	ft-lb	N-m											
B 33803	**	1/4	1/4	1.47	37	1.06	27	3.90	99	8 - 12	11 - 16	6 - 10	8 - 14	Steel	A 04566	A 16474	P 34627	A 04566	0.34	0.16
A 17429	***	1/4	1/4	1.47	37	1.06	27	3.49	89	8 - 12	11 - 16	Finger Tight		Plastic	P 34627	A 16474	P 34627	A 04566	0.23	0.10
B 34247	****	1/4	1/4	1.47	37	1.06	27	3.90	99	8 - 12	11 - 16	20 - 30	27 - 41	Brass	A 16474	A 16474	P 34627	A 04566	0.34	0.16
A 17474	**	3/8	3/8	1.52	39	1.12	28	3.55	90	8 - 12	11 - 16	6 - 10	8 - 14	Steel	A 04566	A 16474	P 34627	A 04566	0.27	0.12
B 34261	****	3/8	3/8	1.52	39	1.12	28	3.55	90	8 - 12	11 - 16	20 - 30	27 - 41	Brass	A 16474	A 16474	P 34627	A 04566	0.42	0.19
B 35519		1/4	1/4	1.47	37	1.06	27	3.49	89	8 - 12	11 - 16	6 - 10	8 - 14	Steel	A 04566	A 16474	P 34627	A 04566	0.33	0.15

Packed Line Valves, Angle

Non-Backseating

NPTFE Inlet to Flare

Part Number	NPTFE A	Flare B	C		D		E		Counterbore Dim F				Standard Cap		Replacement Seal Cap			Wt			
			in	mm	in	mm	in	mm	in	mm	in	mm	in	mm	Material	Seal Cap	Brass	Plastic	Steel	lb	kg
B 33964 ###	1/4	1/4	1.00	25	0.94	24	3.04	77	.254	6.45	.31	7.87	Steel	A 04566	A 16474	P 34627	A 04566	0.31	0.14		
A 11030	1/4	3/8	1.06	27	1.12	28	3.10	79	.317	8.05	.31	7.87	Steel	A 04566	A 16474	P 34627	A 04566	0.25	0.11		
A 13613	3/8	1/4	1.12	28	1.06	27	3.14	80	.379	9.63	.31	7.87	Steel	A 04566	A 16474	P 34627	A 04566	0.33	0.15		
A 11031 **	1/4	1/4	1.00	25	0.94	24	3.04	77	.254	6.45	.31	7.87	Steel	A 04566	A 16474	P 34627	A 04566	0.28	0.13		
A 16472 *	1/4	1/4	1.00	25	0.94	24	3.04	77	.254	6.45	.31	7.87	Brass	A 16474	A 16474	P 34627	A 04566	0.29	0.13		
B 34248 ##	1/4	1/4	1.00	25	0.94	24	3.04	77	.254	6.45	.31	7.87	Steel	A 04566	A 16474	P 34627	A 04566	0.26	0.12		
A 13503	3/8	3/8	1.12	28	1.12	28	3.15	80	.379	9.63	.31	7.87	Steel	A 04566	A 16474	P 34627	A 04566	0.34	0.15		
A 11042	3/8	1/2	1.38	35	1.38	35	3.77	96	.379	9.63	.31	7.87	Steel	A 00409	NA	NA	A 00409	0.51	0.23		
A 19023	1/2	3/8	1.81	46	1.31	33	4.13	105	.504	12.80	.38	9.65	Steel	A 04566	A 16474	P 34627	A 04566	0.59	0.27		

NPTFE x NPTFI, NPTFI x NPTFE

Part Number	A	B	C		D		E		Torque		Standard Cap		Replacement Seal Cap			Wt			
			in	mm	in	mm	in	mm	in	mm	Pack Gland		Material	Seal Cap	Brass	Plastic	Steel	lb	kg
											ft-lb	N-m							
A 13502	NPTFE X NPTFI	1/4	1/4	1.38	35	1.06	27	3.78	96	8 - 12	11 - 16	Steel	A 00409	NA	NA	A 00409	0.49	0.22	
B 32222	NPTFI X NPTFE	1/4	1/4	1.25	32	1.12	28	3.64	92	8 - 12	11 - 16	Steel	A 00409	NA	NA	A 00409	0.51	0.23	

Solder to Flare

Part Number	Solder A	Flare B	C		D		E		F ODE		Torque				Standard Cap		Replacement Seal Cap			Wt	
			in	mm	in	mm	in	mm	in	mm	Pack Gland		Seal Cap		Material	Seal Cap	Brass	Plastic	Steel	lb	kg
											ft-lb	N-m	ft-lb	N-m							
A 17502 **	1/4	1/4	0.71	18	1.03	26	2.75	70	3/8	10	8 - 12	11 - 16	6 - 10	8 - 14	Steel	A 04566	A 16474	P 34627	A 04566	0.30	0.14
A 19042 *	1/4	1/4	0.71	18	1.03	26	2.75	70	3/8	10	8 - 12	11 - 16	6 - 10	8 - 14	Steel	ISS w/ ch P 34970	P 34970	P 34627	A 04566	0.30	0.14
B 34252 *	1/4	1/4	0.71	18	1.03	26	2.75	70	3/8	10	8 - 12	11 - 16	20 - 30	27 - 41	Brass	A 16474	A 16474	P 34627	A 04566	0.31	0.14
B 35161 ##	1/4	1/4	0.71	18	1.03	26	2.75	70	3/8	10	8 - 12	11 - 16	6 - 10	8 - 14	Steel	A 04566	A 16474	P 34627	A 04566	0.31	0.14
A 17503 **	3/8	3/8	0.69	18	1.50	38	2.72	69	1/2	13	8 - 12	11 - 16	6 - 10	8 - 14	Steel	A 04566	A 16474	P 34627	A 04566	0.38	0.17
B 34255 ****	3/8	3/8	0.69	18	1.27	32	2.72	69	1/2	13	8 - 12	11 - 16	20 - 30	27 - 41	Brass	A 16474	A 16474	P 34627	A 04566	0.37	0.17
B 35160 ##	3/8	3/8	0.69	18	1.50	38	2.72	69	1/2	13	8 - 12	11 - 16	6 - 10	8 - 14	Steel	A 04566	A 16474	P 34627	A 04566	0.38	0.17
B 34288 ***	3/8	3/8	0.69	18	1.50	38	2.72	69	1/2	13	8 - 12	11 - 16	FT	FT	Plastic	P 34627	A 16474	P 34627	A 04566	0.31	0.14
A 19022 #####	1/2	1/4	0.64	16	1.20	30	2.67	68	5/8	17	8 - 12	11 - 16	6 - 10	8 - 14	Steel	A 04566	A 16474	P 34627	A 04566	0.32	0.14
A 19021 #####	1/2	3/8	0.64	16	1.20	30	2.67	68	5/8	17	8 - 12	11 - 16	6 - 10	8 - 14	Steel	A 04566	A 16474	P 34627	A 04566	0.39	0.18
A 17913 ##	3/8	1/4	0.69	18	1.17	30	2.72	69	3/8	10	8 - 12	11 - 16	6 - 10	8 - 14	Steel	A 04566	A 16474	P 34627	A 04566	0.30	0.14
A 19044 ***	3/8	1/4	0.69	18	1.17	30	2.72	69	3/8	10	8 - 12	11 - 16	6 - 10	8 - 14	Plastic	P 34600	A 16474	P 34600	A 04566	0.31	0.14
B 33819	3/8	3/8	0.46	12	1.12	28	2.48	63	1/2	13	8 - 12	11 - 16	6 - 10	8 - 14	Steel	A 04566	A 16474	P 34627	A 04566	0.38	0.17
B 35284	3/8	3/8	0.46	12	1.12	28	2.48	63	1/2	13	8 - 12	11 - 16	6 - 10	8 - 14	Steel	A 04566	A 16474	P 34627	A 04566	0.38	0.17

- # Machined to accept OD size tube as indicated.
- ## Steel Seal Cap, Loosely Assembled
- ### Cap finger tight for shipping
- * Brass Seal Cap
- ** Steel Seal Cap
- *** Plastic Seal Cap
- **** Brass Seal Cap, includes copper gasket
- ^ 3/8 Solder also 1/2 FTG
- ^ 1/4 Solder also 3/8 FTG

Packed Line Valves, Two-Way



Features:

- Design Pressure (DP) / Maximum abnormal pressure (MAP): 700 psig, 48 bar
- Continuous operating temperature (COT): -40°F/300°F, -40°C/149°C
- Contact factory or visit website for compatibility with CFC, HCFC, HFC and HFO refrigerants and oils
- UL/cUL Recognized, Conforms to Pressure Equipment Directive 2014/68/EU
- Forged brass body
- Corrosion resistant stem suitable for refrigerants and other industrial fluids
- Asbestos-free stem packing material

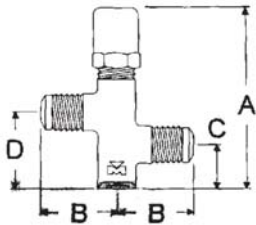

Flare to Flare

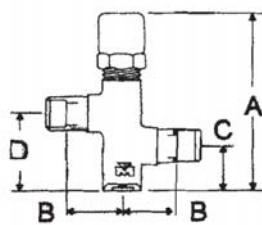

Solder to Solder

Flare to Flare

Part Number	Size	A		B		C		D		Standard Cap		Replacement Seal Cap			Wt	
		in	in	mm	in	mm	in	mm	in	mm	Material	Seal Cap	Brass**	Plastic	Steel*	lb
A 13591	1/4	3.48	88	1.00	25	0.94	24	1.44	37	Steel	A 04566	A 16474	P 34627	A 04566	0.43	0.20
B 33482	1/4	3.40	86	1.00	25	0.94	24	1.40	36	Brass	A 16474	A 16474	P 34627	A 04566	0.51	0.23
A 13595	3/8	3.40	86	1.12	28	0.94	24	1.40	36	Steel	A 04566	A 16474	P 34627	A 04566	0.48	0.22
A 13592	1/2	3.40	86	1.25	32	0.94	24	1.44	37	Steel	A 04566	A 16474	P 34627	A 04566	0.50	0.22

Solder to Solder

Part Number	Size	A		B		C		D		Standard Cap		Replacement Seal Cap			Wt	
		in	in	mm	in	mm	in	mm	in	mm	Material	Seal Cap	Brass**	Plastic	Steel*	lb
A 15580	1/4	3.40	86	0.75	19	0.94	24	1.44	37	Steel	A 04566	A 16474	P 34627	A 04566	0.42	0.19
A 15581	3/8	3.40	86	0.93	24	0.94	24	1.40	36	Steel	A 04566	A 16474	P 34627	A 04566	0.45	0.20
A 15582	1/2	3.40	86	0.87	22	0.94	24	1.40	36	Steel	A 04566	A 16474	P 34627	A 04566	0.54	0.25

* Includes steel cap and copper gasket

** Includes brass cap and copper gasket

Transducer Valves

Features:

- Design Pressure (DP) / Maximum abnormal pressure (MAP): 700 psig, 48 bar
- Continuous operating temperature (COT): -40°F/300°F, -40°C/149°C
- Contact factory or visit website for compatibility with CFC, HCFC, HFC and HFO refrigerants and oils
- UL/cUL Recognized, Conforms to Pressure Equipment Directive 2014/68/EU
- Forged brass body
- Plated steel stem suitable for refrigerants and other industrial fluids non-corrosive to brass and steel
- Asbestos-free stem packing material

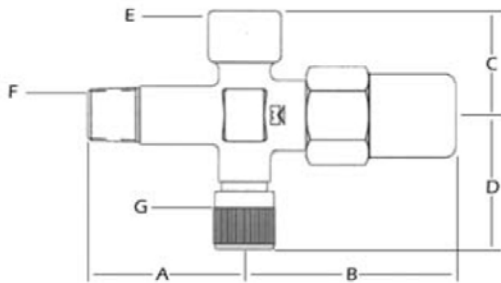

NPTFI x NPTFE

Part Number	A		B		C		D		E NPTFI	F NPTFE	G	Standard Cap			Replacement Seal Cap			Wt	
	in	mm	in	mm	in	mm	in	mm	in	in	in	Material	Seal Cap	Gasket	Brass	Plastic	Steel	lb	kg
B 33837	1.50	38	2.00	51	1.03	26	1.25	32	1/8	1/4	1/4	Steel	A 04566		A 16474	P 34627	A 04566	0.42	0.19
B 34254	1.50	38	2.00	51	1.03	26	1.25	32	1/8	1/4	1/4	Brass	A 04597	A 03468	A 16474	P 34627	A 04566	0.41	0.18
B 34287	1.50	38	2.40	61	1.03	26	1.25	32	1/4	1/4	1/4	Plastic	P 34627		A 16474	P 34627	A 04566	0.35	0.16
B 35334	**	1.50	38	2.40	61	1.03	26	1.25	32	1/4	1/4	Plastic	P 34627		A 16474	P 34627	A 04566	0.34	0.16

NPTFI x ODS

Part Number	A		B		C		D		E NPTFI	F ODS	G	Standard Cap			Replacement Seal Cap			Wt		
	in	mm	in	mm	in	mm	in	mm	in	in	in	Material	Seal Cap	Gasket	Brass	Plastic	Steel	lb	kg	
B 35593	*	1.50	38	2.44	62	1.03	26	1.32	34	1/4	3/8	1/4							0.44	0.20
B 35523	*	1.50	38	2.44	62	1.03	26	1.32	34	1/4	3/8	1/4	Plastic	P 34627		A 16474	P 34627	A 04566	0.35	0.16
B 35162	*	1.50	38	2.04	52	1.00	25	1.28	33	1/8	3/8	1/4	Steel	A 04566		A 16474	P 34627	A 04566	0.43	0.20
NPTFI X ODS, TUBE EXT																				
B 35514	*	3.19	81	2.04	52	1.03	26	1.28	33	1/8	1/2	1/4	Steel	A 04566		A 16474	P 34627	A 04566	0.45	0.21

* Valve core not installed

** Valve core shipped loosely assembled

Packless Diaphragm Valves

Angle



Features:

- Design Pressure (DP) / Maximum abnormal pressure (MAP) with the flow in the direction of the arrow on the body: 700 psig, 48 bar
- Design Pressure (DP) / Maximum abnormal pressure (MAP) with the flow against the direction of the arrow on the body: 350 psig, 24 bar
- Continuous operating temperature (COT): -40°F/300°F, -40°C/149°C
- Contact factory or visit website for compatibility with CFC, HCFC, HFC and HFO refrigerants and oils
- UL/cUL Listed, Conforms to Pressure Equipment Directive 2014/68/EU
- Forged brass body with full size openings for maximum flow and minimum pressure drop
- Diaphragms for positive isolation
- Thermally stable hand wheel for operation in wide temperature ranges

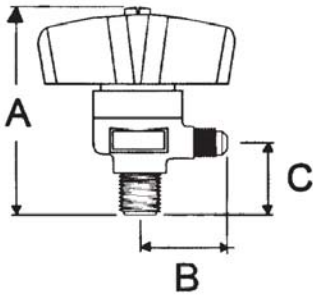

NPTFE to Flare

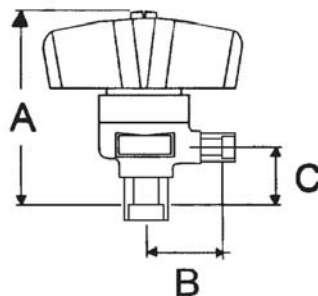

Solder to Solder

NPTFE to Flare

Part Number	NPTFE		Flare		A Open		B		C Min		Wt	
	in	mm	in	mm	in	mm	in	mm	in	mm	lb	kg
A 15525	1/4	6	1/4	6	2.82	72	1.30	33	1.04	26	0.71	0.32
A 15526	1/4	6	3/8	9.5	2.82	72	1.42	36	1.04	26	0.45	0.20
A 15530	1/2	12.7	1/2	12.7	3.70	94	1.86	47	1.44	37	1.17	0.53
A 15531	1/2	12.7	5/8	15.9	3.70	94	1.94	49	1.44	37	1.18	0.54

Solder to Solder

Part Number	OD		A Open		B		C		Wt	
	in	mm	in	mm	in	mm	in	mm	lb	kg
A 15539	1/4	6	2.85	72	1.11	28	0.76	19	0.69	0.31
A 15541	1/2	13	3.70	94	1.56	40	1.06	27	1.14	0.52
A 15542	5/8	17	3.70	94	1.44	37	0.94	24	1.14	0.52

Packless Diaphragm Valves

Straight

Features:

- Design Pressure (DP) / Maximum abnormal pressure (MAP) with the flow in the direction of the arrow on the body: 700 psig, 48 bar
- Design Pressure (DP) / Maximum abnormal pressure (MAP) with the flow against the direction of the arrow on the body: 350 psig, 24 bar
- Continuous operating temperature (COT): -40°F/300°F, -40°C/149°C
- Contact factory or visit website for compatibility with CFC, HCFC, HFC and HFO refrigerants and oils
- UL/cUL Listed, Conforms to Pressure Equipment Directive 2014/68/EU
- Forged brass body with full size openings for maximum flow and minimum pressure drop
- Diaphragms for positive isolation
- Thermally stable hand wheel for operation in wide temperature ranges



Flare to Flare

Part Number	Size		A Open		B		C		D		Wt	
	in	mm	in	mm	in	mm	in	mm	in	mm	lb	kg
A 14833	1/4		2.70	69	1.32	34	1.38	35	0.62	16	0.59	0.27
A 14835	3/8		2.70	69	1.36	35	1.42	36	0.62	16	0.60	0.27
A 14836	1/2		3.46	88	1.62	41	1.86	47	0.84	21	1.03	0.47
A 14837	5/8		3.46	88	1.70	43	1.93	49	0.84	21	1.05	0.48

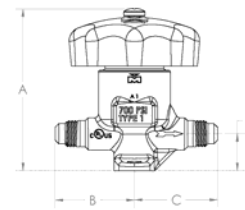

Solder to Solder

Part Number	Size		A Open		B		C		D		Wt	
	in	mm	in	mm	in	mm	in	mm	in	mm	lb	kg
A 14838	1/4	6	2.70	69	1.04	26	1.10	28	0.62	16	0.57	0.26
A 14840	3/8	10	2.70	69	1.04	26	1.10	28	0.62	16	0.57	0.26
A 14841	1/2	13	3.49	89	1.32	34	1.56	40	0.84	21	0.97	0.44
A 14842	5/8	17	3.49	89	1.20	30	1.44	37	0.84	21	1.00	0.45

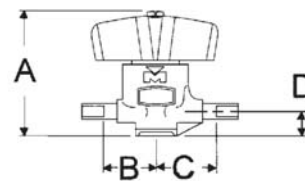

Solder to Solder Ext Ends

Part Number	Size		A Open		B		C		D		Wt	
	in	mm	in	mm	in	mm	in	mm	in	mm	lb	kg
A 14848	1/4	6	2.70	69	2.66	68	2.72	69	0.62	16	0.86	0.39
A 14850C	3/8	10	2.70	69	2.82	72	2.88	73	0.62	16	0.62	0.28
A 14851C	1/2	13	3.49	89	3.04	77	3.28	83	0.84	21		
A 14852C	5/8	17	3.49	89	3.11	79	3.35	85	0.84	21		

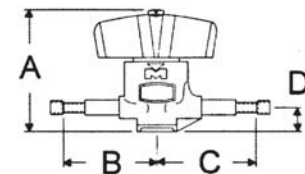

Purge and Drain

Part Number	Size		A Open		B		C		D		Wt	
	in	mm	in	mm	in	mm	in	mm	in	mm	lb	kg
A 18997	3/8	10	2.70	69	1.42	36	1.07	27	0.62	16	0.65	0.29
A 18998	1/4	6	2.70	69	1.38	35	1.07	27	0.62	16	0.58	0.26

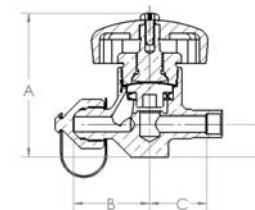

Brass Angle Isolation Valves

Solder to Rotolock



Features:

- Design Pressure (DP) / Maximum abnormal pressure (MAP): 700 psig, 48 bar
- Continuous operating temperature (COT): -40°F/300°F, -40°C/149°C
- Contact factory or visit website for compatibility with CFC, HCFC, HFC and HFO refrigerants and oils
- UL/cUL Recognized, Conforms to Pressure Equipment Directive 2014/68/EU
- 100% tested
- Asbestos-free packing material
- Quick-change packing gland allows easy replacement without refrigerant loss
- Solid brass construction for maximum protection in all environmental conditions
- Backseating design

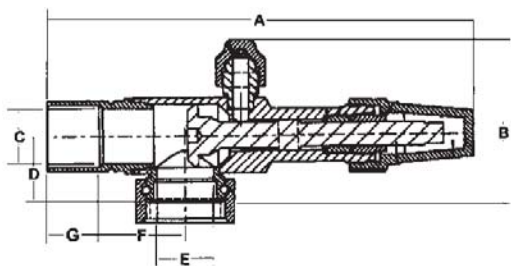

Part Number	Size	Cv	Kv	A		B		C		D		E		F		Flare Size in	Wt		Packing Kit
				in	mm	in	mm	in	mm	in	mm	in	mm	in	mm		lb	kg	
B 34418	* 5/8 X 1 THD	6.00	5.19	5.35	136	2.25	57	0.55	14	0.93	24	0.55	14	0.17	4	1/4	0.68	0.31	A 17420
B 34417	* 7/8 X 1 1/4 THD	15.00	12.97	6.56	167	2.40	61	0.75	19	1.07	27	0.75	19	1.27	32	1/4	1.33	0.61	A 17419
B 34415	** 1 3/8 X 1 3/4 THD	38.00	32.87	9.52	242	3.22	82	1.25	32	1.41	36	1.25	32	1.91	49	3/8	3.26	1.48	A 17419
B 34414	** 1 5/8 X 2 1/4 THD	53.00	45.84	10.04	255	3.35	85	1.50	38	1.58	40	1.50	38	2.19	56	3/8	4.26	1.93	A 17419

Torque To Seal

Part Number	Front Seat		Back Seat		Pack Gland		Rotolock Nut		Plastic Cap	Brass Cap	
	(ft-lb)	(N-m):	(ft-lb)	(N-m):	(ft-lb)	(N-m):	(ft-lb)	(N-m):		(ft-lb)	(N-m)
B 34418	16 - 18	22 - 24	16 - 18	22 - 24	8 - 12	11 - 16	40 - 50	54 - 68	Finger Tight		
B 34417	22 - 40	30 - 54	25 - 45	34 - 61	15 - 20	20 - 27	60 - 80	81 - 109	Finger Tight		
B 34415	22 - 40	30 - 54	25 - 45	34 - 61	15 - 20	20 - 27	60 - 80	81 - 109		40 - 50	54 - 68
B 34414	22 - 40	30 - 54	25 - 45	34 - 61	15 - 20	20 - 27	80 - 100	109 - 136		40 - 50	54 - 68

Rotolock Couplings and Line Break Kits

Union Size	Male Spud	Gasket	Line Break Kit ****
1 1/8	S 36173	P 36168	A 17910
1 3/8	S 36171	P 36169	A 17912
1 5/8	S 36164	P 36167	A 17908

- * Plastic Cap
- ** Brass Cap
- *** Flare Seal Cap and Plastic Seal Cap should be finger tight
- **** Includes Rotolock, Spud and Gasket
- ***** Consult factory

Brass Angle Isolation Valves

Solder to Solder

Features:

- Design Pressure (DP) / Maximum abnormal pressure (MAP): 700 psig, 48 bar
- Continuous operating temperature (COT): -40°F/300°F, -40°C/149°C
- Contact factory or visit website for compatibility with CFC, HCFC, HFC and HFO refrigerants and oils
- UL/cUL Recognized, Conforms to Pressure Equipment Directive 2014/68/EU
- 100% tested
- Asbestos-free packing material
- Quick-change packing gland allows easy replacement without refrigerant loss
- Solid brass construction for maximum protection in all environmental conditions
- Backseating design

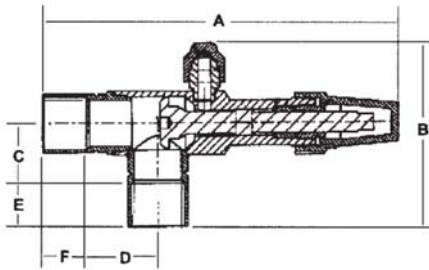

Part Number	Size	Cv	Kv	A		B		C		D		E		F		Flare Size in	Wt		Packing Kit
				in	mm	in	mm	in	mm	in	mm	in	mm	in	mm		lb	kg	
B 34413	* 5/8 X 5/8	6.00	5.19	5.38	137	2.58	66	0.84	21	1.17	30	0.50	13	0.50	13	1/4	0.56	0.25	A 17420
B 34412	* 7/8 X 7/8	15.00	12.97	6.52	166	3.09	78	0.91	23	1.27	32	0.75	19	0.75	19	1/4	1.10	0.50	A 17419
B 35224	* 1 1/8 X 1 1/8	25.00	21.62	7.58	193	3.77	96	1.31	33	1.50	38	0.94	24	0.94	24	3/8	1.85	0.84	A 17419
B 34778	** 1 1/8 X 1 1/8			7.58	193	3.77	96	1.31	33	1.50	38	1.00	25	0.94	24	3/8	2.06	0.93	A 17419
B 34594	** 1 3/8 X 1 3/8	38.00	32.87	9.52	242	4.14	105	1.50	38	1.91	49	1.00	25	1.00	25	3/8	2.87	1.30	A 17419
B 35291	** 1 3/8 X 1 3/8	38.00	32.87	9.52	242	4.14	105	1.50	38	1.91	49	1.00	25	1.00	25	1/4	2.99	1.36	A 17419
B 34595	** 1 5/8 X 1 5/8	53.00	45.84	9.98	253	4.62	117	1.75	44	2.19	56	1.09	28	1.09	28	3/8	3.89	1.76	A 17419

Torque To Seal

Part Number	Front Seat		Back Seat		Pack Gland		Plastic Cap	Brass Cap	
	(ft-lb)	(N-m):	(ft-lb)	(N-m):	(ft-lb)	(N-m):		(ft-lb)	(N-m)
B 34413	16 - 18	22 - 24	16 - 18	22 - 24	8 - 12	11 - 16	Finger Tight		
B 34412	22 - 40	30 - 54	25 - 45	34 - 61	15 - 20	20 - 27	Finger Tight		
B 35224	22 - 40	30 - 54	25 - 45	34 - 61	15 - 20	20 - 27	Finger Tight		
B 34778	22 - 40	30 - 54	25 - 45	34 - 61	15 - 20	20 - 27		40 - 50	54 - 68
B 34594	22 - 40	30 - 54	25 - 45	34 - 61	15 - 20	20 - 27		40 - 50	54 - 68
B 35291	22 - 40	30 - 54	25 - 45	34 - 61	15 - 20	20 - 27		40 - 50	54 - 68
B 34595	22 - 40	30 - 54	25 - 45	34 - 61	15 - 20	20 - 27		40 - 50	54 - 68

* Plastic Cap

** Brass Cap

*** Flare Seal Cap and Plastic Seal Cap should be finger tight

Pressure Relief Valves

Selection Process

While valves are designed to reseal after discharge, it is advisable that they are replaced, since system impurities such as piping debris, solder, and metal shavings can accumulate under the valve disc and inhibit the proper resealing of the valve.

Selection of a relief valve should be based on the discharge capacity required for the system or vessel, based on the size of the equipment and the refrigerant being used. Minimum settings for valves should be at least 25% above the designed Maximum Operating Pressure, while additional consideration must be given if the valve location may experience high ambient temperatures such as an equipment room or rooftop. Sizing valves to the maximum allowable setting will minimize the possibility of seepage or early discharge.

Relief valves operate automatically when the system pressure exceeds the valve set pressure and exerts a force on the valve disc that overcomes the opposing internal spring force. By code, valves may open with allowable tolerances within a +/- 3% range of stamped set pressure, with full discharge capacity realized at 10% above the actual opening pressure.

Relief valves conform to the American Standard Safety Code for Mechanical Refrigeration (ANSI/SHRAE 15), and are designed and manufactured in accordance with ASME Section VIII Division I., certifying specific capacities and identified by the ASME and National Board NB stamps on each valve. These valves are also compliant with European Union Pressure Equipment Directive (PED 2014/68/EU), and exhibit the appropriate EC marking and identification number.

A Pressure Relief Valve (PRV) is a system safety device that has been designed to function in accordance with specific country codes to prevent and protect the operation of systems and vessels above the allowable safe levels.

Discharge Capacity

The minimum required discharge capacity of the pressure relief device or fusible plug for each pressure vessel is determined by the following formula, specified by the ASHRAE Standard 15, Safety Code for Mechanical Refrigeration:

$C = fDL$ where:

C = minimum required discharge capacity of the relief device, lb. air/min (kg air/sec)

D = outside diameter of vessel, ft (m)

L = length of the vessel, ft (m)

f = factor dependent on the kind of refrigerant from Discharge Capacity Chart

Example of relief valve selection:

Information for vessel being protected:

Diameter = 1.33 ft

Length = 3.33 ft

Working Pressure = 350 psi

Information from the table for f values:

Application = R-22

Value of f = 1.6

From the information provided, the required discharge capacity to protect the vessel is determined by solving the minimum discharge capacity formula: $C = fDL$

$C = (1.6)(3.33)(1.33)$

$C = 7.1$ lbs of air/min

Using the calculated discharge 7.1 lbs of air/min and the required pressure of 350 psi, we can select from the product offering.

Using the discharge capacity table, select the row for 350 psi. Valves with capacities that meet the minimum discharge requirement, 7.1, are viable options. Discharge table values A-K allows for selection of a valve based on the inlet and outlet sizes and configurations.

If the desired valve is to have a 3/8" NPTFE inlet and 3/8" Flare outlet, with the outlet being 90°, valve A 15512 is acceptable since it has a discharge table rating of B.

Pressure Relief Valves

Selection Process

Application	Value of F	Metric Value of F
-------------	------------	-------------------

When used on the lowside of a limited-charge cascade system

R-11	1.0	0.082
R-113	1.0	0.082
R-114	1.6	0.131
R-115	2.5	0.203
R-1150	1.0	0.082
R-12	1.6	0.131
R-123	1.0	0.082
R-124	1.6	0.131
R-1270	1.6	0.131
R-13	2.0	0.163
R-134a	1.6	0.131
R-13B1	2.0	0.163
R-14	2.5	0.203
R-142b	1.0	0.082
R-143a	2.0	0.163
R-152a	1.0	0.082
R-170	1.0	0.082
R-22	1.6	0.131
R-23	1.0	0.082
R-290	1.0	0.082
R-32	1.0	0.082
R-401A	1.6	0.131
R-401B	1.6	0.131
R-401C	1.6	0.131
R-402A	2.5	0.203
R-402B	2.0	0.163
R-403A	2.0	0.163
R-403B	2.5	0.203
R-404A	2.5	0.203
R-405A	1.6	0.131
R-406A	1.6	0.131

Application	Value of F	Metric Value of F
-------------	------------	-------------------

When used on the lowside of a limited-charge cascade system

R-407A	2.0	0.163
R-407C	1.6	0.131
R-407D	1.6	0.131
R-407E	1.6	0.131
R-408A	2.0	0.163
R-409A	1.6	0.131
R-409B	1.6	0.131
R-407B	2.5	0.203
R-410A	2.5	0.203
R-410B	2.5	0.203
R-411A	1.6	0.131
R-411B	1.6	0.131
R-411C	1.6	0.131
R-412A	1.6	0.131
R-413A	2.0	0.163
R-414A	1.6	0.131
R-414B	1.6	0.131
R-500	1.6	0.131
R-502	2.5	0.203
R-503	2.0	0.163
R-507A	2.5	0.203
R-508A	1.0	0.082
R-508B	1.0	0.082
R-509A	2.5	0.203
R-600	1.0	0.082
R-600a	1.0	0.082
R-717	0.5	0.041
R-718	0.2	0.016
R-744	1.0	0.082
R-764	1.0	0.082

Pressure Relief Valves

Certification and Part Number Explanation

Certifications:

Conforms to ASME Section VIII, Division 1 and The National Board of Boiler and Pressure Vessel Inspectors, Certificate Number 16,564.

Conforms to Pressure Equipment Directive 2014/68/EU. CE Certification Number 69517, BSI Product Services Notified Body Number 0086.

Canadian Registration Number OG0314.9C.

Certification Documentation Levels:

Level 1 Certificate: A Certificate of Conformance can be provided based on customer request at the time of order placement, or after customer receipt of product. Information necessary to provide a Certificate of Conformance includes: customer name, purchase order number, manufacturing part number, quantity shipped and date of shipment.

Level 2 Certificate: A Certificate of Conformance on a UV-1 Form can be provided based on customer request at the time of order placement, or after customer receipt of product. Information necessary to provide a Certificate of Conformance includes: customer name, purchase order number, manufacturing part number, quantity shipped and date of shipment.

Level 3 Certificate: A Certificate of Conformance can be provided based on customer request at the time of order placement. A serialized certificate can be provided to document the pressure setting of each valve at the point of production.

Part Number Explanation:

Pressure Relief Valves are prefixed to designate the desired pressure setting.

Examples of part numbers using prefixes for the A 15502 relief valve:

To determine the applicable prefix, see chart below.

PSIG	Prefix	PSIG	Prefix
235	D	400	H
300	E	425	I
350	G	450	J

<u>Part Number</u>	<u>Pressure Setting</u>
AD15502	235 psig
AJ15502	450 psig
AQ15502-75	75 psig
AQ15502-240	240 psig
AX15502-475	475 psig
AW15502-625	625 psig

For valves required at non-standard pressure settings listed above, use the chart below to determine prefix by selecting the range at which your requirement falls into. Follow the part number with the exact pressure setting you require.

<u>PSIG Range</u>	<u>Prefix</u>	<u>PSIG Range</u>	<u>Prefix</u>
70 - 249	Q	451 - 550	X
251 - 349	R	551 - 700	W
351 - 449	S		

Pressure Relief Valves

Angle NPTFE to Flare

Features:

- Temperature Range: -40°F/300°F, -40°C/149°C
- Designed primarily for use on liquid receiver applications above the liquid refrigerant level (it is recommended that the factory be consulted before the valves are used on other applications)
- Satisfy ASHRAE Standard 15 code requirements for a refrigerant vessel safety device (Application information can also be found in ASHRAE Guide and Data Book)
- Comply with ASME code for unfired pressure vessels
- Discharge rates are certified by National Board of Boiler & Pressure Vessel Inspectors
- Designed for maximum discharge capacities
- Conforms to Pressure Equipment Directive 2014/68/EU, CRN, Compatible with all CFC, HCFC and HFC refrigerants and oils



Part Number ***	NPTFE A (in)	Flare Outlet B	C (in)	C (mm)	D(in)	D (mm)	Wt (lb)	Wt (kg)	Discharge Table	Working Pressure
A 15512	3/8	3/8	2.43	62	1.21	31	0.37	0.17	B	150 - 700 psi
A 15513	3/8	1/2	2.43	62	1.34	34	0.37	0.17	B	150 - 700 psi
B 33746	1/4	3/8	2.43	62	1.21	31	0.34	0.15	B	150 - 700 psi
B 33754	1/4	1/2	2.43	62	1.34	34	0.43	0.19	B	150 - 700 psi
A 15514	1/2	5/8	4.10	104	1.56	40	1.02	0.46	C	150 - 700 psi
A 18784	3/8	1/2	4.10	104	1.56	40	1.15	0.52	C	150 - 700 psi

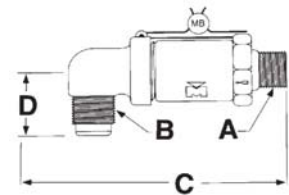

Prefix ***	PSIG	Discharge Capacity (lb air/min)										BAR	Discharge Capacity (kg air/min)																
		A	B	C	D	E	F	G	H	I	J		K	A	B	C	D	E	F	G	H	I	J	K					
D	235	4.3	9.1	20.1	33.7	55.9	91.8	39.0				29.0	60.6	90.3	16	2.0	4.1	9.1	15.3	25.4	41.6	17.7				13.2	27.5	41.0	
E	300	5.4	11.5	25.4	42.5	70.5	115.8	49.2				36.6	76.5	113.9	21	2.4	5.2	11.5	19.3	32.0	52.5	22.3				16.6	34.7	51.7	
G	350	6.3	13.3	29.5	49.3	81.8	134.3	57.1				42.4	88.7	132.1	24	2.9	6.0	13.4	22.4	37.1	60.9	25.9				19.2	40.2	59.9	
H	400	7.1	15.2	33.5	56.1	93.0	152.7	64.9				48.2	150.3		28	3.2	6.9	15.2	25.4	42.2	69.3	29.4				21.9	68.2		
I	425	7.6	16.1	35.6	59.5	98.6	162.0	68.8				51.2	159.4		29	3.4	7.3	16.1	27.0	44.7	73.5	31.2				23.2	72.3		
J	450	8.0	17.0	37.6	62.9	104.3	171.2	72.8				54.1	168.5		31	3.6	7.7	17.1	28.5	47.3	77.7	33.0				24.5	76.4		
X	500		18.8	41.6											34		8.5	18.9											
W	550		20.7	45.6											38		9.4	20.7											
W	600		22.5	49.7											41		10.2	22.5									40.3		
W	650		24.3	53.7											45		11.0	24.4									43.6		
W	700		26.2	57.8											48		11.9	26.2									46.9		

***Standard Pressure Setting Part Number Prefix

PSIG	Prefix	PSIG	Prefix
235	D	400	H
300	E	425	I
350	G	450	J

***Non-Standard Pressure Setting Part Number Prefixes:

PSIG Range	Prefix	PSIG Range	Prefix	
70 - 249	Q	451 - 550	X	Follow the part number with the pressure setting required.
251 - 349	R	551 - 700	W	
351 - 449	S			

Pressure Relief Valves

Atmospheric - NPTFE Inlet

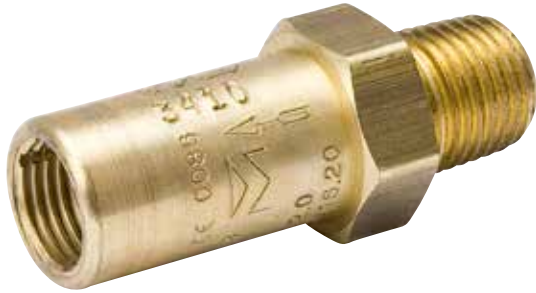

Features:

- Temperature Range: -40°F/300°F, -40°C/149°C
- Designed primarily for use on liquid receiver applications above the liquid refrigerant level (it is recommended that the factory be consulted before the valves are used on other applications)
- Satisfy ASHRAE Standard 15 code requirements for a refrigerant vessel safety device (Application information can also be found in ASHRAE Guide and Data Book)
- Comply with ASME code for unfired pressure vessels
- Discharge rates are certified by National Board of Boiler & Pressure Vessel Inspectors
- Designed for maximum discharge capacities
- Conforms to Pressure Equipment Directive 2014/68/EU, CRN, Compatible with all CFC, HCFC and HFC refrigerants and oils

Part Number ***	NPTFE Inlet A (in)	B (in)	B (mm)	C (in)	C (mm)	Wt (lb)	Wt (kg)	Discharge Table	Working Pressure
A 15508	1/8	1.88	48	0.75	19	0.12	0.05	A	150 - 450 psi
A 15509	1/4	2.00	51	0.75	19	0.14	0.06	A	150 - 450 psi
A 17430	3/8	2.12	54	1.00	25	0.25	0.11	B	150 - 700 psi
B 33755	1/4	2.12	54	1.00	25	0.30	0.14	B	150 - 700 psi

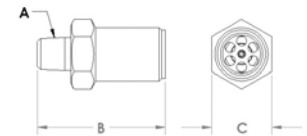

Prefix ***	PSIG	Discharge Capacity (lb air/min)										BAR	Discharge Capacity (kg air/min)										
		A	B	C	D	E	F	G	H	I	J		K	A	B	C	D	E	F	G	H	I	J
D	235	4.3	9.1	20.1	33.7	55.9	91.8	39.0		29.0	60.6	90.3	16	2.0	4.1	9.1	15.3	25.4	41.6	17.7	13.2	27.5	41.0
E	300	5.4	11.5	25.4	42.5	70.5	115.8	49.2		36.6	76.5	113.9	21	2.4	5.2	11.5	19.3	32.0	52.5	22.3	16.6	34.7	51.7
G	350	6.3	13.3	29.5	49.3	81.8	134.3	57.1		42.4	88.7	132.1	24	2.9	6.0	13.4	22.4	37.1	60.9	25.9	19.2	40.2	59.9
H	400	7.1	15.2	33.5	56.1	93.0	152.7	64.9		48.2	150.3		28	3.2	6.9	15.2	25.4	42.2	69.3	29.4	21.9	68.2	
I	425	7.6	16.1	35.6	59.5	98.6	162.0	68.8		51.2	159.4		29	3.4	7.3	16.1	27.0	44.7	73.5	31.2	23.2	72.3	
J	450	8.0	17.0	37.6	62.9	104.3	171.2	72.8		54.1	168.5		31	3.6	7.7	17.1	28.5	47.3	77.7	33.0	24.5	76.4	
X	500		18.8	41.6									34		8.5	18.9							
W	550		20.7	45.6									38		9.4	20.7							
W	600		22.5	49.7					88.9				41		10.2	22.5					40.3		
W	650		24.3	53.7					96.2				45		11.0	24.4					43.6		
W	700		26.2	57.8					103.4				48		11.9	26.2					46.9		

***Standard Pressure Setting Part Number Prefixes:

PSIG	Prefix	PSIG	Prefix
235	D	400	H
300	E	425	I
350	G	450	J

***Non-Standard Pressure Setting Part Number Prefixes:

PSIG Range	Prefix	PSIG Range	Prefix
70 - 249	Q	451 - 550	X
251 - 349	R	551 - 700	W
351 - 449	S		

Follow the part number with the pressure setting required.

Pressure Relief Valves

Internal

Features:

- Temperature Range: -40°F/300°F, -40°C/149°C
- Designed primarily for use on liquid receiver applications above the liquid refrigerant level (it is recommended that the factory be consulted before the valves are used on other applications)
- Satisfy ASHRAE Standard 15 code requirements for a refrigerant vessel safety device (Application information can also be found in ASHRAE Guide and Data Book)
- Comply with ASME code for unfired pressure vessels
- Discharge rates are certified by National Board of Boiler & Pressure Vessel Inspectors
- Designed for maximum discharge capacities
- Conforms to Pressure Equipment Directive 2014/68/EU, CRN, Compatible with all CFC, HCFC and HFC refrigerants and oils



Part Number ***	NPTFE A (in)	B (in)	B (mm)	C (in)	C (mm)	Wt (lb)	Wt (kg)	Discharge Table	Working Pressure
B 34425	3/4	1.65	42	1.13	29	0.36	0.16	B	150 - 700 psi
A 17970	1	2.37	60	1.31	33	0.57	0.26	I	150 - 450 psi
A 18473	1 1/2	3.14	80	1.90	48	1.73	0.78	F	150 - 450 psi

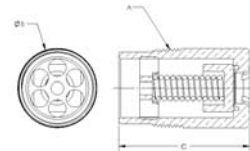

Prefix ***	PSIG	Discharge Capacity (lb air/min)										BAR	Discharge Capacity (kg air/min)									
		A	B	C	D	E	F	G	H	I	J		K	A	B	C	D	E	F	G	H	I
D	235	4.3	9.1	20.1	33.7	55.9	91.8	39.0	29.0	60.6	90.3	16	2.0	4.1	9.1	15.3	25.4	41.6	17.7	13.2	27.5	41
E	300	5.4	11.5	25.4	42.5	70.5	115.8	49.2	36.6	76.5	113.9	21	2.4	5.2	11.5	19.3	32.0	52.5	22.3	16.6	34.7	51
G	350	6.3	13.3	29.5	49.3	81.8	134.3	57.1	42.4	88.7	132.1	24	2.9	6.0	13.4	22.4	37.1	60.9	25.9	19.2	40.2	59
H	400	7.1	15.2	33.5	56.1	93.0	152.7	64.9	48.2	150.3	28	3.2	6.9	15.2	25.4	42.2	69.3	29.4	21.9	43.6	68	
I	425	7.6	16.1	35.6	59.5	98.6	162.0	68.8	51.2	159.4	29	3.4	7.3	16.1	27.0	44.7	73.5	31.2	23.2	46.2	72	
J	450	8.0	17.0	37.6	62.9	104.3	171.2	72.8	54.1	168.5	31	3.6	7.7	17.1	28.5	47.3	77.7	33.0	24.5	48.8	76	
X	500		18.8	41.6								34		8.5	18.9							
W	550		20.7	45.6								38		9.4	20.7							
W	600		22.5	49.7				88.9				41		10.2	22.5			40.3				
W	650		24.3	53.7				96.2				45		11.0	24.4			43.6				
W	700		26.2	57.8				103.4				48		11.9	26.2			46.9				

***Standard Pressure Setting Part Number Prefixes:

PSIG	Prefix	PSIG	Prefix
235	D	400	H
300	E	425	I
350	G	450	J

***Non-Standard Pressure Setting Part Number Prefixes:

PSIG Range	Prefix	PSIG Range	Prefix
70 - 249	Q	451 - 550	X
251 - 349	R	551 - 700	W
351 - 449	S		

Follow the part number with the pressure setting required.

Pressure Relief Valves

Straight Thru



Features:

- Temperature Range: -40°F/300°F, -40°C/149°C
- Designed primarily for use on liquid receiver applications above the liquid refrigerant level (it is recommended that the factory be consulted before the valves are used on other applications)
- Satisfy ASHRAE Standard 15 code requirements for a refrigerant vessel safety device (Application information can also be found in ASHRAE Guide and Data Book)
- Comply with ASME code for unfired pressure vessels
- Discharge rates are certified by National Board of Boiler & Pressure Vessel Inspectors
- Designed for maximum discharge capacities
- Conforms to Pressure Equipment Directive 2014/68/EU, CRN, Compatible with all CFC, HCFC and HFC refrigerants and oils

NPTFE Inlet to Flare Outlet

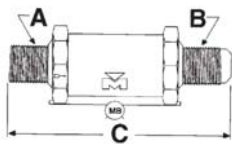

Part Number ****	NPTFE A (in)	Flare B (in)	C (in)	C (mm)	Wt (lb)	Wt (kg)	Discharge Table	Working Pressure
A 15501	1/4	3/8	2.65	67	0.20	0.09	A	150 - 450 psi
A 15502	3/8	3/8	2.81	71	0.34	0.15	B	150 - 700 psi
A 15503	3/8	1/2	3.00	76	0.35	0.16	B	150 - 700 psi
B 33752	1/4	3/8	2.81	71	0.00	0.00	B	150 - 700 psi
B 33753	1/4	1/2	3.00	76	0.41	0.18	B	150 - 700 psi
A 15504	1/2	5/8	4.20	107	0.84	0.38	C	150 - 700 psi
A 18737	3/8	5/8	4.20	107	0.98	0.45	C	150 - 700 psi
A 18783	3/8	1/2	4.20	107	0.95	0.43	C	150 - 700 psi

Prefix ***	PSIG	Discharge Capacity (lb air/min)										BAR	Discharge Capacity (kg air/min)											
		A	B	C	D	E	F	G	H	I	J		K	A	B	C	D	E	F	G	H	I	J	K
D	235	4.3	9.1	20.1	33.7	55.9	91.8	39.0		29.0	60.6	90.3	16	2.0	4.1	9.1	15.3	25.4	41.6	17.7		13.2	27.5	41
E	300	5.4	11.5	25.4	42.5	70.5	115.8	49.2		36.6	76.5	113.9	21	2.4	5.2	11.5	19.3	32.0	52.5	22.3		16.6	34.7	51
G	350	6.3	13.3	29.5	49.3	81.8	134.3	57.1		42.4	88.7	132.1	24	2.9	6.0	13.4	22.4	37.1	60.9	25.9		19.2	40.2	59
H	400	7.1	15.2	33.5	56.1	93.0	152.7	64.9		48.2	150.3		28	3.2	6.9	15.2	25.4	42.2	69.3	29.4		21.9	68	
I	425	7.6	16.1	35.6	59.5	98.6	162.0	68.8		51.2	159.4		29	3.4	7.3	16.1	27.0	44.7	73.5	31.2		23.2	72	
J	450	8.0	17.0	37.6	62.9	104.3	171.2	72.8		54.1	168.5		31	3.6	7.7	17.1	28.5	47.3	77.7	33.0		24.5	76	
X	500		18.8	41.6									34		8.5	18.9								
W	550		20.7	45.6									38		9.4	20.7								
W	600		22.5	49.7					88.9				41		10.2	22.5				40.3				
W	650		24.3	53.7					96.2				45		11.0	24.4				43.6				
W	700		26.2	57.8					103.4				48		11.9	26.2				46.9				

***Standard Pressure Setting Part Number Prefixes:

PSIG	Prefix	PSIG	Prefix
235	D	400	H
300	E	425	I
350	G	450	J

***Non-Standard Pressure Setting Part Number Prefixes:

PSIG Range	Prefix	PSIG Range	Prefix	
70 - 249	Q	451 - 550	X	Follow the part number with the pressure setting required.
251 - 349	R	551 - 700	W	
351 - 449	S			

Pressure Relief Valves

Straight Thru

NPTFE Inlet to NPTFI Outlet

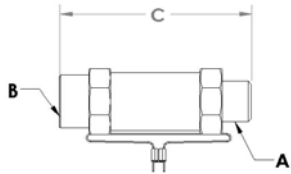

Part Number ***	NPTFE A (in)	NPTFI B (in)	C (in)	C (mm)	Wt (lb)	Wt (kg)	Discharge Table	Working Pressure	
A 18736	3/8	3/4	4.00	102	0.98	0.45	C	150 - 700 psi	
A 18762	1/2	3/4	4.00	102	0.94	0.43	C	150 - 700 psi	
A 15506	3/4	3/4	4.95	126	1.53	0.69	D	150 - 450 psi	
A 17840	1	1	4.60	117	1.45	0.66	E	150 - 450 psi	
A 18735	3/4	1	4.60	117	1.49	0.68	E	150 - 450 psi	
A 17834	1 1/4	1 1/4	4.94	125	2.00	0.91	F	150 - 450 psi	
A 18387	1	1	4.94	125	1.81	0.82	F	150 - 450 psi	
A 18356	1/2	1/2	3.99	101	0.96	0.43	G	150 - 450 psi	
A 18357	1/2	3/4	3.99	101	0.89	0.40	G	150 - 450 psi	
A 18358	3/4	3/4	3.99	101	0.93	0.42	G	150 - 450 psi	
AW18422	*	3/4	3/4	4.95	126	1.60	0.73	H	600 - 700 psi
A 18424	*	1	1	4.77	121	1.58	0.72	J	150 - 350 psi
A 18425	*	1 1/4	1 1/4	5.24	133	2.17	0.99	K	150 - 450 psi
A 18444	*	1	1 1/4	5.24	133	1.98	0.90	K	150 - 450 psi
*	PTFE Seat								

Straight Thread Inlet to Flare Outlet

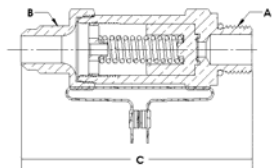

Part Number ***	Inlet A (in)	Outlet B (in)	C (in)	C (mm)	Wt (lb)	Wt (kg)	Discharge Table	Working Pressure
B 35413	7/8 - 14 UNF - 2A	5/8	4.19	106	0.92	0.42	C	150 - 700 psi

Straight Thread Inlet to NPTFI Outlet

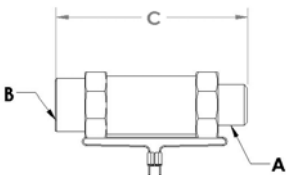

Part Number ***	Inlet A (in)	Outlet B (in)	C (in)	C (mm)	Wt (lb)	Wt (kg)	Discharge Table	Working Pressure
B 34444	7/8 - 14UNF - 2A	3/4	5.00	127	1.52	0.69	D	150 - 450 psi
B 34519	1 5/16 - 12UNF - 2S	1	4.38	111	1.37	0.62	E	150 - 450 psi
B 34580	1 5/8 - 12UNF - 2A	1 1/4	5.00	127	2.00	0.91	F	150 - 450 psi
A 18540	7/8 - 14UNF - 2A	3/4	3.99	101	0.96	0.44	G	150 - 450 psi

***Standard Pressure Setting Part Number Prefixes:

PSIG	Prefix	PSIG	Prefix
235	D	400	H
300	E	425	I
350	G	450	J

***Non-Standard Pressure Setting Part Number Prefixes:

PSIG Range	Prefix	PSIG Range	Prefix	
70 - 249	Q	451 - 550	X	Follow the part number with the pressure setting required.
251 - 349	R	551 - 700	W	
351 - 449	S			

Rupture Disc and Pressure Gauge

NPTFE X NPTFI



Features:

- Continuous operating temperature (COT): -40°F/300°F, -40°C/149°C
- Contact factory or visit website for compatibility with CFC, HCFC, HFC and HFO refrigerants and oils
- Conforms to Pressure Equipment Directive 2014/68/EU Category 4 Product, Certified to meet ASME Code
- Wide range of pressure settings available
- One-piece brass design assures setting accuracy
- Non-fragmenting disc

ASME Code

Guidelines for the application of Rupture Disc Devices in combination with pressure relief valves is provided by ASME Code. The following is an excerpt from the ASME Code, Section VIII, Division I, UG-127.

A rupture disc device may be installed between a pressure relief valve and the vessel provided:

The marked capacity of a pressure relief valve, when installed with a rupture disc device between the inlet of the valve and the vessel, shall be multiplied by a factor of 0.90 of the rated relieving capacity of the valve alone.

The space between a rupture disc device and a pressure relief valve shall be provided with a pressure gage, or suitable telltale indicator. This arrangement permits detection of disc rupture or leakage.

Users are warned that a rupture disc will not burst at its design pressure if back pressure build up in the space between the disc and the pressure relief valve which will occur should leakage develop in the rupture disc due to corrosion or other cause.

Part Number *	A NPTFE (in)	B NPTFI (in)	C NPT (in)	D (in)	D (mm)	E (in)	E (mm)	Wt (lb)	Wt (kg)
A 17971	1/2	1/2	1/8	3	71	1	13	0.51	0.23

Prefix	PSIG	Bar
D	235	16
E	300	21
G	350	24
H	400	28
I	425	29
J	450	31

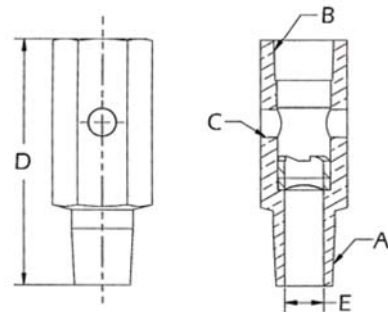

Pressure Gauge

P 36214



RELIEFMASTER® Change-Over Manifold

Features:

- Design Pressure (DP) / Maximum abnormal pressure (MAP): 700 psig, 48 bar
- Continuous operating temperature (COT): -40°F/300°F, -40°C/149°C
- Contact factory or visit website for compatibility with CFC, HCFC, HFC and HFO refrigerants and oils
- Allows easy replacement of attached relief valves and rupture discs while the system is operative.
- Dual internal seats ensure complete isolation of individual circuits.
- Available with various inlet connections.
- Multiple cap options available.

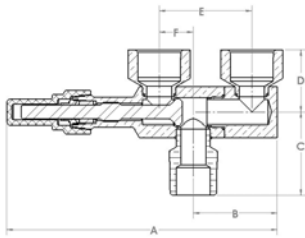

NPTFE X NPTFI

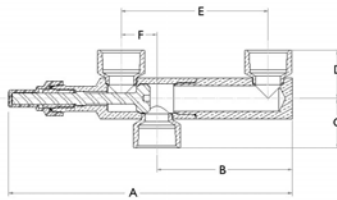

NPTFI X NPTFI

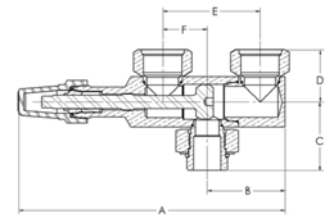

STRAIGHT THREAD

NPTFE X NPTFI

Part Number	Inlet NPTFE	Outlet NPTFI	A		B		C		D		E		F		Torques to Seal						Wt	
			in	mm	in	mm	in	mm	in	mm	in	mm	in	mm	Front Seat (ft-lb)	Back Seat (ft-lb)	Front Seat (N-m)	Back Seat (N-m)	Pack Gland (ft-lb) (N-m)		lb	kg
A 17923	1	1	8.51	216	2.44	62	2.39	49	1.94	49	3.13	80	1.70	43	22 - 40	30 - 54	22 - 45	30 - 61	15 - 25	20 - 34	4.55	2.06
A 17924	1 1/4	1 1/4	8.80	224	2.44	62	2.45	54	2.11	54	3.13	80	1.70	43	22 - 40	30 - 54	22 - 45	30 - 61	15 - 25	20 - 34	5.60	2.54
A 17921	1/2	1/2	5.98	152	1.75	44	1.76	35	1.36	35	2.04	52	0.75	19	16 - 18	22 - 24	16 - 18	22 - 24	8 - 12	11 - 16	1.47	0.66
A 17922	3/4	3/4	6.01	153	1.85	47	1.84	35	1.38	35	2.04	52	0.75	19	16 - 18	22 - 24	16 - 18	22 - 24	8 - 12	11 - 16	1.28	0.58

NPTFI X NPTFI

Part Number	Inlet NPTFE	Outlet NPTFI	A		B		C		D		E		F		Torques to Seal						Wt	
			in	mm	in	mm	in	mm	in	mm	in	mm	in	mm	Front Seat (ft-lb)	Back Seat (ft-lb)	Front Seat (N-m)	Back Seat (N-m)	Pack Gland (ft-lb) (N-m)		lb	kg
B 35273	1 1/4	1 1/4	11.34	288	5.41	137	1.94	50	1.97	50	5.88	149	1.43	36	22 - 40	30 - 54	22 - 45	30 - 61	15 - 25	20 - 34	6.00	2.72

STRAIGHT THREAD

Part Number	Inlet	Outlet	A		B		C		D		E		F		Torques to Seal						Wt	
			in	mm	in	mm	in	mm	in	mm	in	mm	in	mm	Front Seat (ft-lb)	Back Seat (ft-lb)	Front Seat (N-m)	Back Seat (N-m)	Pack Gland (ft-lb) (N-m)		lb	kg
B 34550	7/8-14UNF 2A	7/8-14UNF 2B	5.98	152	1.85	47	1.65	35	1.38	35	2.04	52	0.75	19	16 - 18	22 - 24	16 - 18	22 - 24	8 - 12	11 - 16	1.46	0.66
B 34559	1 5/16-12UNF 2A	1 5/16-12UNF 2B	8.53	217	2.50	64	2.22	43	1.69	43	3.13	80	1.43	36	22 - 40	30 - 54	22 - 45	30 - 61	15 - 25	20 - 34	3.14	1.42
B 34654	1 5/8-12UNF 2A	1 5/8-12UNF 2B	8.53	217	2.50	64	2.19	46	1.81	46	3.13	80	1.43	36	22 - 40	30 - 54	22 - 45	30 - 61	15 - 25	20 - 34	3.64	1.65

RELIEFMASTER® Ball Valve Manifold



Features:

- Design Pressure (DP) / Maximum abnormal pressure (MAP): 1305 psig, 90 bar
- Continuous operating temperature (COT): -40°F/300°F, -40°C/149°C
- Contact factory or visit website for compatibility with CFC, HCFC, HFC and HFO refrigerants and oils
- Suitable for CO2 applications
- Allows easy replacement of attached relief valves and rupture discs while the system is operative.
- Offers solution for applications requiring a ball valve style pressure relief valve manifold
- Internally equalized ball design
- Rupture-proof encapsulated stem

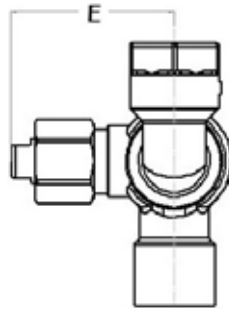
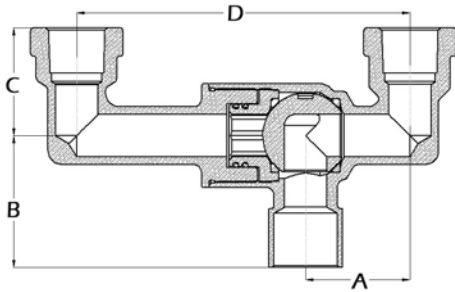

Part Number	Inlet x Outlet	A		B		C		D		E		Wt	
		in	mm	in	mm	in	mm	in	mm	in	mm	lb	kg
A 18730	7/8 ODS X 1/2 NPT	1.45	37	1.83	46	1.50	38	4.63	118	2.07	52	1.60	0.73
A 19043	1/2" NPTFE X 1/2" NPTFI	1.45	37	1.83	46	1.50	38	4.63	118	2.07	53	1.58	0.72

Fusible Pipe Plugs, Connectors, Bushings

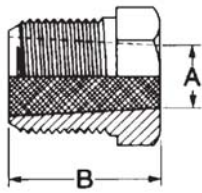

Fusible Pipe Plugs - NPTFE

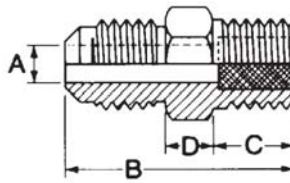

Half Union - Flare to NPTFE

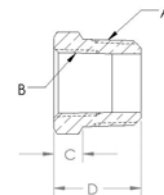

Bushing NPT to NPTFI

Fusible Pipe Plugs - NPTFE

Cat Number	Part Number UL	Part Number CE	Size NPTFE	Hex	Flare	A (in)	B (in)	C (in)	D (in)	Melting Temp °F	Box Qty	Wt(lb)
FP-A	A 14058	B 35133	1/8	7/16		0.22	0.59			283	10	0.022
FP-B	A 14059	B 35134	1/4	9/16		0.25	0.78			283	15	0.050
FP-C	A 14060	B 35135	3/8	11/16		0.38	0.84			283	15	0.084
FP-A	A 14017	B 35122	1/8	7/16		0.22	0.59			210	10	0.024
FP-B	A 14018	B 35123	1/4	9/16		0.25	0.78			210	15	0.054
FP-C	A 14021	B 35125	3/8	11/16		0.38	0.84			210	15	0.090
FP-A	A 15214		1/8	7/16		0.22	0.59			168	10	0.024
FP-B	A 14019	B 35124	1/4	9/16		0.25	0.78			168	15	0.054
FP-C	A 14022	B 35126	3/8	11/16		0.38	0.84			168	15	0.095

Half Union - Flare to NPTFE

Cat Number	Part Number UL	Part Number CE	Size NPTFE	Hex	Flare	A (in)	B (in)	C (in)	D (in)	Melting Temp °F	Box Qty	Wt(lb)
FU-4B	A 14062		1/4	9/16	1/4	0.19	1.25	0.56	0.19	283	10	0.065
FU-6C	A 14064		3/8	11/16	3/8	0.28	1.44	0.56	0.25	283	10	0.126
FU-4B	A 14023		1/4	9/16	1/4	0.19	1.25	0.56	0.19	210	10	0.057
FU-6C	A 14026		3/8	11/16	3/8	0.28	1.44	0.56	0.25	210	10	0.122
FU-4B	A 14024		1/4	9/16	1/4	0.19	1.25	0.56	0.19	168	10	0.048
FU-6C	A 14027		3/8	11/16	3/8	0.28	1.44	0.56	0.25	168	10	0.098

Bushing - NPT to NPTFI

Cat Number	Part Number	NPTE A (in)	NPTFI B (in)	C (in)	D (in)	Hex	Box Qty	Wt(lb)
R1-AB	A 08756	1/8	1/4	0.61	0.92	11/16	25	0.054
R1-BA	A 00630	1/4	1/8	0.19	0.69	9/16	25	0.020
R1-CB	A 00631	3/8	1/4	0.25	0.75	11/16	25	0.034
R1-DB	A 00492	1/2	1/4	0.28	0.84	7/8	25	0.080
R1-DC	A 00632	1/2	3/8	0.28	0.84	7/8	25	0.051
R1-EC	A 00493	3/4	3/8	0.31	0.92	1 1/16	10	0.111
R1-ED	A 00633	3/4	1/2	0.31	0.92	1 1/16	10	0.092

DRYMASTER® High Capacity Filter Driers

Liquid Line Flare



Features:

- Design Pressure (DP) / Maximum abnormal pressure (MAP): 700 psig
- Maximum working temperature: 160°F/70°C
- Compatible with all CFC, HCFC, HFC and HFO refrigerants and oils, and refrigerants requiring XH-11 desiccant
- UL/cUL Listed, Conforms to Pressure Equipment Directive 2014/68/EU
- Solid core design
- High retention filter for removal of particulate as small as 25 microns
- High pressure shell and connections
- Powder paint finish approved for marine applications
- 100% copper connection for solder models

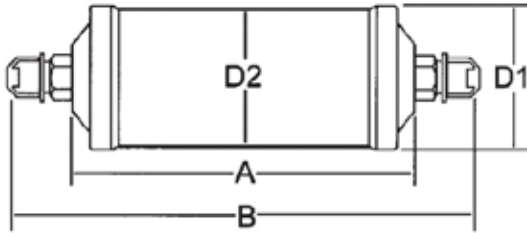

Part Number	Model	Des Size (in)	A (in)	B (in)	D1 (in)	D2 (in)	Wt (lb)	Liquid Capacity (tons)						Water Capacity (drops)											
								R 1	R 4	R 5	R 2	R 4	R 4	R134a		R404A		R507		R22		R407C		R410A	
								3	0	0	2	0	1	75°F	125°F	75°F	125°F	75°F	125°F	75°F	125°F	75°F	125°F	75°F	125°F
A 18184	FL-032	3 1/4	2.57	4.29	1.85	1.69	0.44	2	1	1	2	2	2	82	70	87	78	87	77	80	71	74	52	59	51
A 18185	FL-033	3 3/8	2.57	4.81	1.85	1.69	0.54	3	3	2	4	4	4	82	70	87	78	87	77	80	71	74	52	59	51
A 18186	FL-052	5 1/4	2.94	4.66	2.32	2.10	0.57	2	1	1	2	2	2	157	131	166	146	167	145	152	132	137	90	103	90
A 18187	FL-053	5 3/8	2.94	5.18	2.32	2.10	0.66	4	3	3	4	4	4	157	131	166	146	167	145	152	132	137	90	103	90
A 18188	FL-082	8 1/4	3.98	5.71	2.32	2.10	0.75	2	1	1	2	2	2	255	212	269	237	271	235	246	215	222	145	166	144
A 18189	FL-083	8 3/8	3.98	6.22	2.32	2.10	0.85	4	3	3	4	4	4	255	212	269	237	271	235	246	215	222	145	166	144
A 18190	FL-084	8 1/2	3.98	6.54	2.32	2.10	0.92	8	6	6	8	8	8	255	212	269	237	271	235	246	215	222	145	166	144
A 18191	FL-162	16 1/4	4.33	6.05	3.12	2.92	1.48	2	1	1	2	2	2	473	402	498	444	501	439	459	405	419	296	330	291
A 18192	FL-163	16 3/8	4.33	6.57	3.12	2.92	1.52	4	3	3	5	4	4	473	402	498	444	501	439	459	405	419	296	330	291
A 18193	FL-164	16 1/2	4.33	6.89	3.12	2.92	1.59	9	7	7	10	9	10	473	402	498	444	501	439	459	405	419	296	330	291
A 18194	FL-165	16 5/8	4.33	7.25	3.12	2.92	1.70	12	9	9	13	13	14	473	402	498	444	501	439	459	405	419	296	330	291
A 18195	FL-303	30 3/8	7.33	9.57	3.15	3.00	3.20	4	3	3	5	4	4	949	813	999	893	1006	885	925	817	846	607	673	595
A 18196	FL-304	30 1/2	7.33	9.89	3.15	3.00	3.27	9	7	7	10	10	10	949	813	999	893	1006	885	925	817	846	607	673	595
A 18197	FL-305	30 5/8	7.33	10.25	3.15	3.00	3.36	13	10	10	15	14	15	949	813	999	893	1006	885	925	817	846	607	673	595
A 18801	FL-306	30 3/4	7.33	10.17	3.15	3.00	1.44	12	11	11	15	15	17	949	813	999	893	1006	885	925	817	846	607	673	595
A 18198	FL-413	41 3/8	7.35	9.59	3.65	3.50	4.12	5	3	3	5	5	5	1279	1095	1346	1204	1355	1193	1246	1101	1140	819	908	802
A 18199	FL-414	41 1/2	7.35	9.91	3.65	3.50	3.98	10	7	7	11	10	11	1279	1095	1346	1204	1355	1193	1246	1101	1140	819	908	802
A 18200	FL-415	41 5/8	7.35	10.27	3.65	3.50	4.47	15	11	11	17	16	16	1279	1095	1346	1204	1355	1193	1246	1101	1140	819	908	802

Water capacity data rated according to AHRI 710 standards.

DRYMASTER® High Capacity Filter Driers

Liquid Line Solder

Features:

- Design Pressure (DP) / Maximum abnormal pressure (MAP): 700 psig
- Maximum working temperature: 160°F/70°C
- Compatible with all CFC, HCFC, HFC and HFO refrigerants and oils, and refrigerants requiring XH-11 desiccant
- UL/cUL Listed, Conforms to Pressure Equipment Directive 2014/68/EU
- Solid core design
- High retention filter for removal of particulate as small as 25 microns
- High pressure shell and connections
- Powder paint finish approved for marine applications
- 100% copper connection for solder models

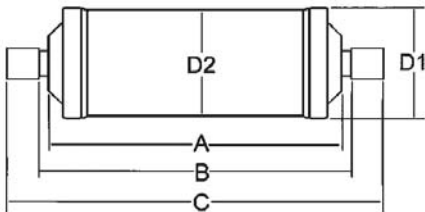

Part Number	Model	Des Size (in)	Cu In	A (in)	B (in)	C (in)	D1 (in)	D2 (in)	Wt (lb)	Liquid Capacity (tons)						Water Capacity (drops)											
										R 1	R 4	R 5	R 2	R 4	R 4	R134a		R404A		R507		R22		R407C		R410A	
										3	0	0	2	0	1	75°F	125°F	75°F	125°F	75°F	125°F	75°F	125°F	75°F	125°F	75°F	125°F
A 18598	SD-032	3 1/4		2.57	3.30	4.03	1.85	1.69	0.42	2	1	1	2	2	2	82	70	87	78	87	77	80	71	74	52	59	51
A 18599	SD-033	3 3/8		2.57	3.30	4.03	1.85	1.69	0.43	4	3	3	4	4	4	82	70	87	78	87	77	80	71	74	52	59	51
A 18654	SD-052	5 1/4		2.94	3.67	4.40	2.32	2.10	0.54	2	1	1	2	2	2	157	131	166	146	167	145	152	132	137	90	103	90
A 18655	SD-053	5 3/8		2.94	3.67	4.40	2.32	2.10	0.56	4	3	3	4	4	4	157	131	166	146	167	145	152	132	137	90	103	90
A 18656	SD-082	8 1/4		2.94	4.70	5.43	2.32	2.10	0.73	2	1	1	2	2	2	255	212	269	237	271	235	246	215	222	145	166	144
A 18657	SD-083	8 3/8		2.94	4.70	5.43	2.32	2.10	0.74	4	3	3	5	4	4	255	212	269	237	271	235	246	215	222	145	166	144
A 18658	SD-084	8 1/2		2.94	4.84	5.71	2.32	2.10	0.76	8	6	6	9	8	8	255	212	269	237	271	235	246	215	222	145	166	144
A 18699	SD-163	16 3/8		4.33	5.06	5.79	3.12	2.92	1.42	5	3	3	5	5	5	473	402	498	444	501	439	459	405	419	296	330	291
A 18700	SD-164	16 1/2		4.33	5.19	6.06	3.12	2.92	1.46	10	7	7	10	10	10	473	402	498	444	501	439	459	405	419	296	330	291
A 18701	SD-165	16 5/8		4.33	5.28	6.22	3.12	2.92	1.50	12	10	10	14	13	14	473	402	498	444	501	439	459	405	419	296	330	291
A 18702	SD-166	16 3/4		4.33	5.51	6.69	3.12	2.92	1.54	13	11	10	15	14	16	473	402	498	444	501	439	459	405	419	296	330	291
A 18703	SD-167	16 7/8		4.33	5.35	6.77	3.12	2.92	1.58	12	11	11	15	15	17	473	402	498	444	501	439	459	405	419	296	330	291
A 18741	SD-303	30 3/8		7.33	8.06	8.79	3.15	3.00	3.24	5	3	3	5	4	5	949	813	999	893	1006	885	925	817	846	607	673	595
A 18742	SD-304	30 1/2		7.33	8.20	9.07	3.15	3.00	3.10	10	7	7	11	10	11	949	813	999	893	1006	885	925	817	846	607	673	595
A 18743	SD-305	30 5/8		7.33	8.28	9.22	3.15	3.00	2.97	14	11	11	16	15	16	949	813	999	893	1006	885	925	817	846	607	673	595
A 18800	SD-306	30 3/4		7.33	8.52	9.70	3.15	3.00	3.20	13	11	11	15	15	16	949	813	999	893	1006	885	925	817	846	607	673	595
A 18744	SD-307	30 7/8		7.33	8.36	9.78	3.15	3.00	3.01	19	15	14	21	20	22	949	813	999	893	1006	885	925	817	846	607	673	595
A 18745	SD-309	30 1 1/8		7.33	8.16	9.81	3.15	3.00	3.26	24	20	19	28	27	30	949	813	999	893	1006	885	925	817	846	607	673	595
A 18746	SD-413	41 3/8		7.35	8.08	8.81	3.65	3.50	4.13	5	4	3	6	5	5	1279	1095	1346	1204	1355	1193	1246	1101	1140	819	908	802
A 18747	SD-414	41 1/2		7.35	8.22	9.09	3.65	3.50	4.02	10	8	8	11	11	12	1279	1095	1346	1204	1355	1193	1246	1101	1140	819	908	802
A 18748	SD-415	41 5/8		7.35	8.30	9.24	3.65	3.50	4.05	16	12	12	17	16	17	1279	1095	1346	1204	1355	1193	1246	1101	1140	819	908	802
A 18749	SD-417	41 7/8		7.35	8.38	9.80	3.65	3.50	4.41	19	15	15	22	21	23	1279	1095	1346	1204	1355	1193	1246	1101	1140	819	908	802
A 18823	SD-419	41 1 1/8		7.35	8.18	9.83	3.65	3.50	1.83	24	19	18	27	26	28	1279	1095	1346	1204	1355	1193	1246	1101	1140	819	908	802

Water capacity data rated according to AHRI 710 standards.

DRYMASTER® Filter Driers

Suction Line



Features:

- Design Pressure (DP) / Maximum abnormal pressure (MAP): 700 psig
- Maximum working temperature: 160°F/70°C
- Contact factory or visit website for compatibility with CFC, HCFC, HFC and HFO refrigerants and oils
- UL/cUL Listed, Conforms to Pressure Equipment Directive 2014/68/EU
- Solid core design, composed of 70% activated alumina/ 30% molecular sieves for exceptional moisture and acid removal
- High retention filter for removal of particulate as small as 25 microns
- Dual access fitting for precise pressure drop measurements
- Powder paint finish approved for marine applications

Flare Connection

Part Number	Model	Dessicant Cu In	Size (in)	A (in)	B (in)	D1 (in)	D2 (in)	Wt (lb)	Nominal Capacity (tons) Evaporator Temp 40°F		
									R134a	R404A, R507	R22, R407C, R410A
A 18856	FDF-083-TT	8	3/8	3.98	6.22	2.32	2.1	0.54	1.2	1.3	1.8
A 18857	FDF-084-TT	8	1/2	3.98	6.54	2.32	2.1	0.54	1.5	2.3	2.8
A 18858	FDF-085-TT	8	5/8	3.98	6.9	2.32	2.1	0.55	2.7	3.6	4.3
A 17225	FDF-164-TT	16	1/2	4.33	6.89	3.12	2.92	1.63	1.8	2.5	3.2
A 17226	FDF-165-TT	16	5/8	4.33	7.25	3.12	2.92	1.50	2.8	3.9	4.4
A 18860	FDF-166-TT	16	3/4	4.33	7.17	3.12	2.92	0.95	3.3	4.8	5.7

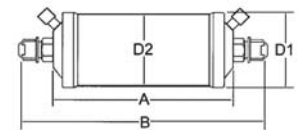

Solder Connection

Part Number	Model	Dessicant Cu In	Size (in)	A (in)	B (in)	C (in)	D1 (in)	D2 (in)	Wt (lb)	Nominal Capacity (tons) Evaporator Temp 40°F		
										R134a	R404A, R507	R22, R407C, R410A
A 18844	FDS-083-TT	8	3/8	3.98	4.70	5.43	2.32	2.10	0.43	1.2	1.3	1.8
A 18845	FDS-084-TT	8	1/2	3.98	4.84	5.71	2.32	2.10	0.43	1.5	2.3	2.8
A 18846	FDS-085-TT	8	5/8	3.98	4.92	5.87	2.32	2.10	0.43	2.7	3.6	4.3
A 17224	FDS-164-TT	16	1/2	4.33	5.20	6.06	3.12	2.92	1.50	1.8	2.5	3.2
A 17227	FDS-165-TT	16	5/8	4.33	5.28	6.22	3.12	2.92	1.52	2.8	3.9	4.4
A 17228	FDS-166-TT	16	3/4	4.33	5.35	6.69	3.12	2.92	1.56	3.3	4.8	5.7
A 17229	FDS-167-TT	16	7/8	4.33	5.19	6.77	3.12	2.92	1.59	4.1	5.5	6.4
A 17230	FDS-169-TT	16	1 1/8	4.33	5.16	6.81	3.11	3.00	1.45	4.8	6.6	7.6
A 17301	FDS-305-TT	30	5/8	7.34	8.29	9.22	3.11	3.00	3.08	3.1	4.2	5.0
A 17301	FDS-306-TT	30	3/4	7.34	8.52	9.70	3.11	3.00	3.10	3.8	5.4	6.2
A 17302	FDS-307-TT	30	7/8	7.34	8.36	9.78	3.11	3.00	3.13	4.3	6.2	7.2
A 17231	FDS-309-TT	30	1 1/8	7.34	8.17	9.81	3.11	3.00	3.27	5.7	7.5	8.8
A 17232	FDS-3011-TT	30	1 3/8	7.34	8.31	10.25	3.11	3.00		6.8	9.2	10.7
A 17233	FDS-3013-TT	30	1 5/8	7.34	8.39	10.57	3.11	3.00	1.45	8.2	11.0	12.8
A 18889	FDS-415-TT	41	5/8	7.36	8.31	9.25	3.65	3.50	1.88	3.6	5.0	5.9
A 18890	FDS-416-TT	41	3/4	7.36	8.54	9.72	3.65	3.50	1.88	4.7	6.3	7.3
A 18891	FDS-417-TT	41	7/8	7.36	8.38	9.80	3.65	3.50	1.88	5.2	7.3	8.5
A 18892	FDS-419-TT	41	1 1/8	7.36	8.19	9.84	3.65	3.50	1.88	6.4	8.8	10.2
A 18893	FDS-4111-TT	41	1 3/8	7.36	8.33	10.27	3.65	3.50	1.88	7.6	10.3	12.0
A 18894	FDS-4113-TT	41	1 5/8	7.36	8.41	10.59	3.65	3.50	1.88	9.0	12.3	14.0

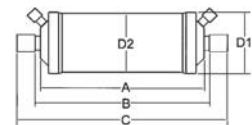

DRYMASTER® High Capacity Heat Pump

Features:

- Design Pressure (DP) / Maximum abnormal pressure (MAP): 700 psig
- Maximum working temperature: 160°F/70°C
- Compatible with all CFC, HCFC, HFC and HFO refrigerants and oils, and refrigerants requiring XH-11 desiccant
- UL/cUL Listed, Conforms to Pressure Equipment Directive 2014/68/EU
- High retention filter for removal of particulate as small as 25 microns
- High pressure shell and connections
- Powder paint finish approved for marine applications

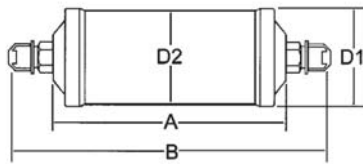

Flare Connection

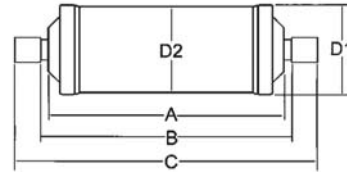

Solder Connection

Flare Connection

Part Number	Model	Des. Cu. In	Size (in)	A (in)	B (in)	D1 (in)	D2 (in)	Wt (lb)	Liquid Capacity (tons)			Water Capacity (drops)											
									R134a	R404A, R507	R22, R407C, R410A	R134a		R404A		R507		R22		R407C		R410A	
												75°F	125°F	75°F	125°F	75°F	125°F	75°F	125°F	75°F	125°F	75°F	125°F
A 19002	HPF-083	8	3/8	3.85	6.09	2.65	2.50	1.34	2.3	1.6	2.5	200	189	206	196	210	196	200	185	194	179	182	167
A 19003	HPF-084	8	1/2	3.85	6.41	2.65	2.50	1.40	2.6	1.8	2.8	200	189	206	196	210	196	200	185	194	179	182	167
A 19007	HPF-163	16	3/8	4.41	6.65	3.15	3.00	2.18	5.2	3.8	5.8	386	368	403	381	409	379	387	357	374	346	352	325
A 19008	HPF-164	16	1/2	4.41	6.97	3.15	3.00	2.24	8.2	5.8	9.3	386	368	403	381	409	379	387	357	374	346	352	325
A 19009	HPF-165	16	5/8	4.41	7.33	3.15	3.00	2.34	10.8	8.4	11.7	386	368	403	381	409	379	387	357	374	346	352	325
A 19013	HPF-304	30	1/2	7.40	9.96	3.15	3.00	3.31	8.0	5.7	8.8	856	809	894	846	910	840	858	793	833	769	780	720
A 19014	HPF-305	30	5/8	7.40	10.32	3.15	3.00	3.41	10.8	8.0	11.9	856	809	894	846	910	840	858	793	833	769	780	720

Solder Connection

Part Number	Model	Des. Cu. In	Size (in)	A (in)	B (in)	C (in)	D1 (in)	D2 (in)	Wt (lb)	Liquid Capacity (tons)			Water Capacity (drops)											
										R134a	R404A, R507	R22, R407C, R410A	R134a		R404A		R507		R22		R407C		R410A	
													75°F	125°F	75°F	125°F	75°F	125°F	75°F	125°F	75°F	125°F	75°F	125°F
A 19000	HPS-083	8	3/8	3.85	4.58	5.31	2.65	2.50	1.23	2.3	1.6	2.5	200	189	206	196	210	196	200	185	194	179	182	167
A 19001	HPS-084	8	1/2	3.85	4.72	5.59	2.65	2.50	1.25	2.6	1.8	2.8	200	189	206	196	210	196	200	185	194	179	182	167
A 19004	HPS-163	16	3/8	4.41	5.14	5.87	3.15	3.00	2.12	5.2	3.8	5.8	386	368	403	381	409	379	387	357	374	346	352	325
A 19005	HPS-164	16	1/2	4.41	5.27	6.14	3.15	3.00	2.07	8.2	5.8	9.3	386	368	403	381	409	379	387	357	374	346	352	325
A 19006	HPS-165	16	5/8	4.41	5.36	6.30	3.15	3.00	2.12	10.8	8.4	11.7	386	368	403	381	409	379	387	357	374	346	352	325
A 19010	HPS-304	30	1/2	7.40	8.26	9.13	3.15	3.00	3.16	8.0	5.7	8.8	856	809	894	846	910	840	858	793	833	769	780	720
A 19011	HPS-305	30	5/8	7.40	8.35	9.29	3.15	3.00	3.18	10.8	8.0	11.9	856	809	894	846	910	840	858	793	833	769	780	720
A 19012	HPS-307	30	7/8	7.40	8.42	9.84	3.15	3.00	3.26	12.2	9.1	13.4	856	809	894	846	910	840	858	793	833	769	780	720

DRYMASTER® Filter Driers

Replaceable Core Shells



Features:

- For use in liquid and suction lines
- Contact factory or visit website for compatibility with CFC, HCFC, HFC and HFO refrigerants and oils
- Powder coat withstands 500 hour salt spray per ASTM B 117
- Pressure rating of 870 psig (60 bar)
- UL/cUL Listed, CE certified and RoHS compliant
- Slotted Aluminum lid for ease of assembly
- Stainless Steel bolts and brass plug
- O-ring seal for ease of assembly and removal
- Maximum Working Temperature: 160°F, 70°C

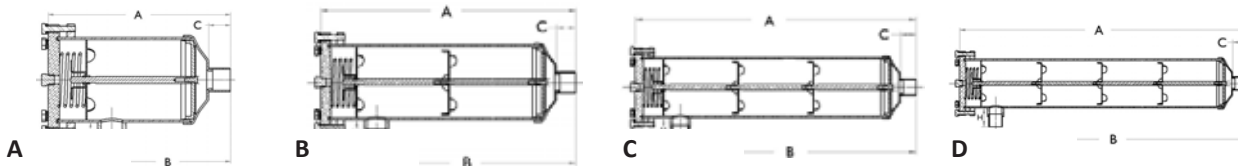

Part Number	Model	Size (in)	Core Size Cu In	A (in)	B (in)	C (in)	H (in)	Wt (lb)	Drawing	Liquid Capacity (tons)					Recommended Spacing for clearance to install components (in)
										R134a	R404A	R507	R22/R407C	R410A	
A 18583		5/8	48	9.33	5.98	0.87	1.46	8.51	A	22.0	16.0	16.0	23.10	23.6	9.0
A 18584		7/8	48	9.53	6.18	1.06	1.65	8.57	A	37.3	26.7	26.0	39.4	40.0	9.0
A 18585		1 1/8	48	9.61	6.26	1.14	1.73	8.64	A	52.8	37.9	37.0	56.20	57.0	9.0
A 18586		1 3/8	48	9.72	6.38	1.26	1.85	8.77	A	73.1	52.3	52.0	77.4	78.6	9.0
A 18587		1 5/8	48	9.80	6.46	1.34	1.93	8.80	A	83.9	60.7	60.0	89.8	91.4	9.0
A 18588		2 1/8	48	10.08	6.34	1.65	2.24	9.14	A	124.1	92.6	90.0	131.3	137.3	9.0
A 18664		2 5/8	48	10.30	6.24	2.17	2.36	11.46	A	91.5	67.0	65.0	95.6	99.1	9.0
A 18589		7/8	96	15.24	11.89	1.06	1.65	11.36	B	38.1	27.2	27.0	40.1	40.6	14.0
A 18590		1 1/8	96	15.32	11.97	1.14	1.73	11.62	B	59.6	43.0	42.0	63.4	64.2	14.0
A 18591		1 3/8	96	15.43	12.09	1.26	1.85	11.31	B	77.1	55.2	54.0	81.9	83.0	14.0
A 18592		1 5/8	96	15.51	12.17	1.34	1.93	17.55	B	93.4	66.9	66.0	99.2	100.9	14.0
A 18593		2 1/8	96	15.75	12.05	1.65	2.24	17.55	B	136.3	99.7	97.0	142.3	147.6	14.0
A 18665		2 5/8	96	16.00	11.95	2.17	2.36	17.55	B						
A 18604		1 1/8	144	20.63	17.28	1.14	1.73	20.08	C	59.3	42.5	42.0	63.2	64.0	19.5
A 18605		1 3/8	144	20.75	17.40	1.26	1.85	14.35	C	84.9	60.6	60.0	90.3	91.6	19.5
A 18606		1 5/8	144	20.83	17.48	1.34	1.93	14.39	C	95.1	68.3	67.0	101	102.6	19.5
A 18607		2 1/8	144	21.10	17.36	1.65	2.24	20.08	C	118.2	85.1	84.0	125.9	128.3	19.5
A 18608		1 3/8	192	26.69	23.35	1.26	1.85	22.60	D	88.4	63.7	63.0	94.2	95.7	25.0
A 18609		1 5/8	192	26.77	23.43	1.34	1.93	22.60	D	102.9	74.4	73.0	110	111.8	25.0
A 18610		2 1/8	192	27.01	23.31	1.65	2.24	17.70	D	128.7	92.3	91.0	136.4	138.8	25.0

P 37671 Mounting Bracket

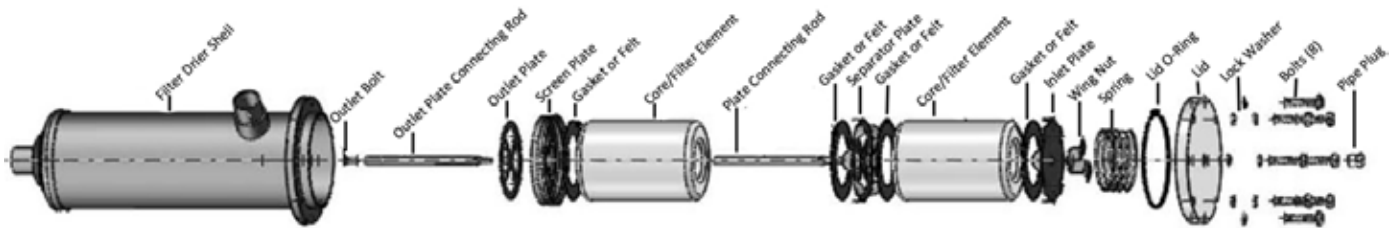

Replacement Kits

Includes: Spring, Wing Nut, Inlet Plate, Separator Plate, Plate Connecting Rod, Screen Plate, Outlet Plate, Outlet Plate Connecting Rod, Outlet Bolt

A 18715C - Single Core Carriage

A 18716C - 2 Core Carriage

A 18717C - 3 Core Carriage

A 18718C - 4 Core Carriage

A 18719 - Hardware Kit includes Pipe Plug, 8 Bolts, 8 Washers

A 18734 - Lid O-Ring Kit includes 20 Lid O-Rings

DRYMASTER® Filter Drier Cores

48 Cubic Inch

Activated Core

- High acid adsorption
- Liquid or suction line applications



High Capacity Core

- High drying capacity
- Liquid or suction line applications



Charcoal Core

- Wax removal
- Liquid or suction line applications



Suction Line Filter

- Filter solid contaminants
- Low pressure drop
- Bi-directional



Activated Core

Part Number	Size Cu In	A (in)	B (in)	C (in)	Wt (lb)	Water Capacity (drops)											
						R134a		R404A		R507		R22		R407C		R410A	
						75°F	125°F	75°F	125°F	75°F	125°F	75°F	125°F	75°F	125°F	75°F	125°F
P 37266	48	1.77	3.70	5.51	1.78	587	466	605	462	534	384	534	384	397	263	358	194

Water capacity data rated according to AHRI 710 standards.

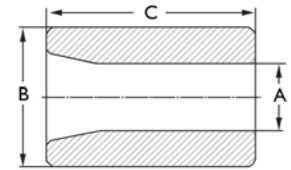

Charcoal Core

Part Number	Size Cu In	A (in)	B (in)	C (in)	Wt (lb)	Water Capacity (drops)											
						R134a		R404A		R507		R22		R407C		R410A	
						75°F	125°F	75°F	125°F	75°F	125°F	75°F	125°F	75°F	125°F	75°F	125°F
P 37267	48	1.77	3.70	5.51	1.68	533	414	551	414	497	347	497	347	364	231	339	186

Water capacity data rated according to AHRI 710 standards.

High Capacity Core

Part Number	Size Cu In	A (in)	B (in)	C (in)	Wt (lb)	Water Capacity (drops)											
						R134a		R404A		R507		R22		R407C		R410A	
						75°F	125°F	75°F	125°F	75°F	125°F	75°F	125°F	75°F	125°F	75°F	125°F
P 36818	48	1.77	3.70	5.51	1.68	1584	1402	1671	1517	1456	1276	1456	1276	1326	1012	1084	889
P 36818 (2)	96	1.77	3.70	5.51		3169	2798	3342	3034	2912	2552	2912	2552	2651	2024	2169	1778
P 36818 (3)	144	1.77	3.70	5.51		4753	4204	5014	4554	4368	3828	4368	3828	3977	3035	3254	2667
P 36818 (4)	192	1.77	3.70	5.51		6337	5606	6685	6068	5824	5104	5824	5104	5303	4047	4338	3553

Water capacity data rated according to AHRI 710 standards.

Suction Line Filter

Part Number	Size Cu In	A (in)	B (in)	C (in)	Wt (lb)	Filtration
A 18733C	48	3.75	2.40	5.58	0.67	10 microns

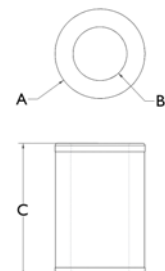

Sight Glass/ Moisture Indicators

Hermetically Sealed, Solder x Solder



Features:

- Design Pressure (DP) / Maximum abnormal pressure (MAP): Charted Below
- Continuous operating temperature (COT): -40°F/185°F, -40°C/85°C
- Contact factory or visit website for compatibility with CFC, HCFC, HFC and HFO refrigerants and oils
- UL/cUL Recognized, Conforms to Pressure Equipment Directive 2014/68/EU
- Designed for maximum flow and minimum pressure drop
- Large viewing window and indicator for better visibility
- Provides accurate identification of system conditions

Brass Body

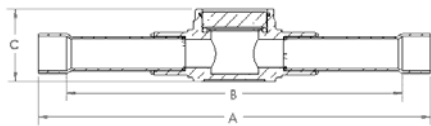

Part Number	Size		A		B		C		MAP		Wt	
	in	mm	in	mm	in	mm	in	mm	psig	bar	lb	kg
A 18114	1/4	6	4.50	114	3.87	98	1.06	27	700	48	0.31	0.14
A 18115	3/8	10	4.50	114	3.71	94	1.06	27	700	48	0.38	0.17
A 18116	1/2	13	5.74	146	4.79	122	1.06	27	700	48	0.50	0.22
A 18117	5/8	17	5.74	146	4.56	116	1.30	33	700	48	0.52	0.24
A 18118	3/4	19	6.80	173	5.50	140	1.30	33	700	48	0.56	0.25
A 18119	7/8	22	7.16	182	5.69	145	1.42	36	700	48	0.41	0.19

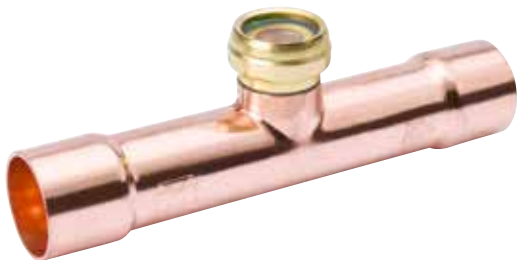

Copper Body

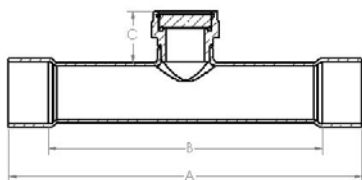

Part Number	Size		A		B		C		MAP		Wt	
	in	mm	in	mm	in	mm	in	mm	psi	bar	lb	kg
A 18120	1 1/8	29	6.30	160	4.49	114	0.98	25	700	48	0.59	0.27
A 18121	1 3/8	35	7.87	200	5.95	151	0.98	25	700	48	0.75	0.34
A 18122	1 5/8	41	7.87	200	5.71	145	0.98	25	700	48	1.01	0.46
A 18123	2 1/8	54	7.87	200	5.20	132	0.98	25	650	45	1.40	0.64

Moisture Content PPM

HFC and HCFC Refrigerants	75°F Liquid Refrigerant		100°F Liquid Refrigerant	
	Green/Dry	Yellow/Wet	Green/Dry	Yellow/Wet
R12	5	20	10	35
R22	30	125	45	185
R134a	25	110	45	175
R404A	20	75	25	130
R407C	30	145	55	230
R410a	25	165	45	300
R502	10	45	20	65
R507	15	75	30	140

Sight Glass/ Moisture Indicators

Replaceable Element, Copper Body, Solder x Solder

Features:

- Design Pressure (DP) / Maximum abnormal pressure (MAP): charted below
- Continuous operating temperature (COT): -40°F/185°F, -40°C/85°C
- Contact factory or visit website for compatibility with CFC, HCFC, HFC and HFO refrigerants and oils
- UL/cUL Recognized, Conforms to Pressure Equipment Directive 2014/68/EU
- Designed for maximum flow and minimum pressure drop
- Large viewing window and indicator for better visibility
- Provides accurate identification of system conditions

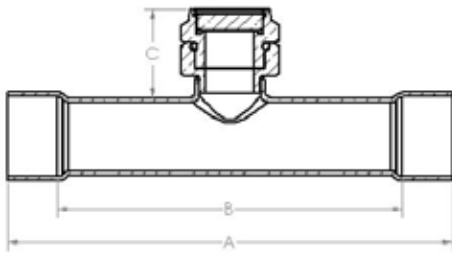
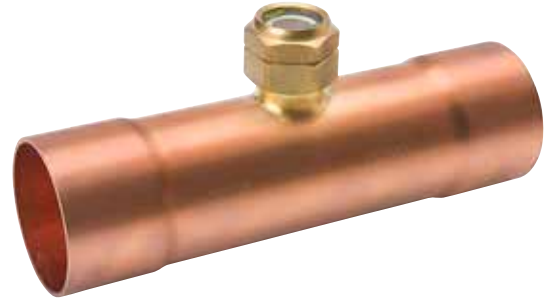

Part Number	Size		A		B		C		MAP		Wt		Replacement Non-Hermetic Cap Assembly
	in	mm	in	mm	in	mm	in	mm	psi	bar	lb	kg	
A 18124	1 1/8	29	6.30	160	4.49	114	1.26	32	700	48	0.65	0.29	A 18623
A 18125	1 3/8	35	7.87	200	5.95	151	1.26	32	700	48			A 18623
A 18126	1 5/8	41	7.87	200	5.71	145	1.26	32	700	48			A 18623
A 18127	2 1/8	54	7.87	200	5.20	132	1.26	32	650	45			A 18623

Moisture Content PPM				
HFC and HCFC Refrigerants	75°F Liquid Refrigerant		100°F Liquid Refrigerant	
	Green/Dry	Yellow/Wet	Green/Dry	Yellow/Wet
R12	5	20	10	35
R22	30	125	45	185
R134a	25	110	45	175
R404A	20	75	25	130
R407C	30	145	55	230
R410a	25	165	45	300
R502	10	45	20	65
R507	15	75	30	140

Sight Glass/ Moisture Indicators

Hermetically Sealed, Flare



Features:

- Design Pressure (DP) / Maximum abnormal pressure (MAP): 700 psig, 48 bar
- Continuous operating temperature (COT): -40°F/185°F, -40°C/85°C
- Contact factory or visit website for compatibility with CFC, HCFC, HFC and HFO refrigerants and oils
- UL/cUL Recognized, Conforms to Pressure Equipment Directive 2014/68/EU
- Designed for maximum flow and minimum pressure drop
- Large viewing window and indicator for better visibility
- Provides accurate identification of system conditions

Flare x Flare

Part Number	Size		A		Thread	B		Wt	
	in	mm	in	mm		in	mm	lb	kg
A 18101	1/4	6	1.06	27	7/16-20UNF	2.75	70	0.33	0.15
A 18102	3/8	10	1.06	27	5/8-18 UNF	3.00	76	0.43	0.20
A 18103	1/2	13	1.30	33	3/4-16 UNF	3.25	83	0.50	0.23
A 18104	5/8	17	1.30	33	7/8-14 UNF	3.45	88	0.53	0.24

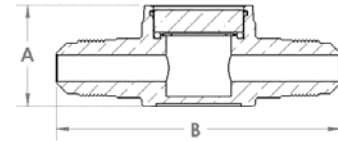

Flare x Swivel

Part Number	Size		A		B		Wt	
	in	mm	in	mm	in	mm	lb	kg
A 18110	1/4	6	1.06	27	2.90	74	0.35	0.16
A 18111	3/8	10	1.06	27	2.95	75	0.38	0.17
A 18112	1/2	13	1.30	33	3.37	86	0.61	0.28
A 18113	5/8	17	1.30	33	3.37	86	0.63	0.29

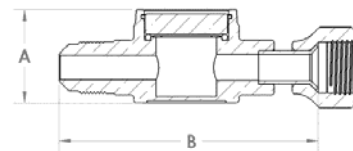

M x F Flare

Part Number	Size		A		Thread	B		Wt	
	in	mm	in	mm		in	mm	lb	kg
A 18106	1/4	6	1.06	27	7/16-20 UNF	2.45	62	0.31	0.14
A 18107	3/8	10	1.30	33	5/8-18 UNF	3.00	76	0.55	0.25
A 18108	1/2	13	1.30	33	3/4-16 UNF	2.85	72	0.46	0.21

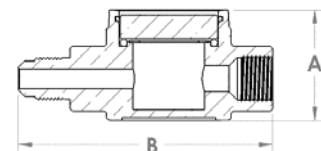

Strainers

Copper Inline, Solder

Features:

- Design Pressure (DP) / Maximum abnormal pressure (MAP): 700 psig, 48 bar
- Continuous operating temperature (COT): -40°F/300°F, -40°C/149°C
- Contact factory or visit website for compatibility with CFC, HCFC, HFC and HFO refrigerants and oils
- UL/cUL Listed, Conforms to Pressure Equipment Directive 2014/68/EU

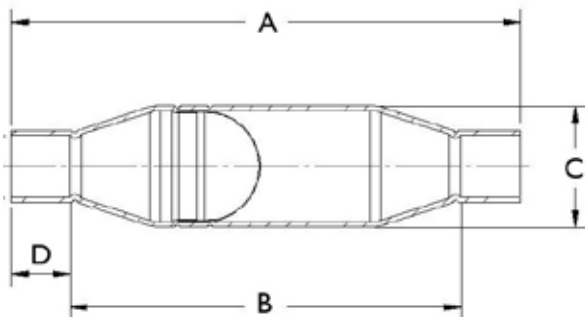

Part Number	Size		A		B		C		D		Internal Assembly Volume	Screen Mesh	Screen Area	Filtration Capacity	Wt	
	in	mm	in	mm	in	mm	in	mm	in	mm					lb	kg
A 18025	3/8	3/8	3.12	79	2.50	64	0.75	19	0.31	8	0.79	100	.4	175	0.06	0.03

45° Flare Fittings



Features:

- Recommended Design Pressure (DP/ Maximum abnormal pressure (MAP): 700 psig, 48 bar
- In conformance with Refrigeration Fitting Standards SAE J513, Military Standards MS-35867 through MS-35873 inclusive, MS-35919, MS-24815 and MS-16993
- Fabricated from brass forgings or drawn brass rod eliminating the possibility of seepage by porosity
- Accurately machined and fully protected against damage during shipping, handling and storage to assure tight leak-proof joints
- Smooth interior finish provides unrestricted flow and reduced pressure drop

Tees are described by first sizing the run (1 to 2) and then the branch (3).



The letter in the first position of the catalog number is derived from the name of the fitting. Examples:

- T - Tees
- B - Bonnets
- E - Elbows
- N - Nuts
- U - Unions
- F - Fuse Plugs

The numeral in the second position of the catalog number designates the combination of threads on the fitting.

- 4 - Forged Nut
- 2 - Flare to Flare Fitting (U2, E2, T2)
- 1 - External Pipe Thread (U1, E1, T1)

Indicators preceding the numeral in the second position of the catalog number designate the following:

- S - Short (forged nuts)
- R - Internal pipe to flare fitting (excludes tees)
- R - Reducing flare nut (forged nuts)
- R - Pipe thread to flare on the run (tees)

The last two characters in the catalog number designate the size. (Flare sizes are designated by numerals, pipe sizes are designated by letters.)

- | | |
|----------|---------|
| 3 - 3/16 | A - 1/8 |
| 4 - 1/4 | B - 1/4 |
| 5 - 5/16 | C - 3/8 |
| 6 - 3/8 | D - 1/2 |
| 8 - 1/2 | E - 3/4 |
| 10 - 5/8 | F - 1 |
| 12 - 3/4 | |

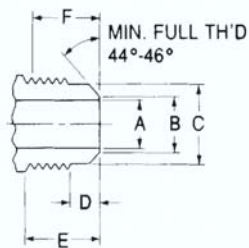

External Flare:

Size	A (in)	B (in)	C (in)	D (in)	E (in)	Min Rull Thread F (in)	Size Thread
3/16	0.13	0.16	0.30	0.13	0.44	0.43	3/8 - 24
1/4	0.19	0.22	0.34	0.16	0.50	0.41	7/16 - 20
5/16	0.22	0.25	0.41	0.19	0.56	0.47	1/2 - 20
3/8	0.28	0.31	0.53	0.22	0.53	0.53	5/8 - 18
1/2	0.41	0.44	0.64	0.25	0.75	0.66	3/4 - 16
5/8	0.50	0.53	0.75	0.28	0.88	0.75	7/8 - 14
3/4	0.63	0.72	0.94	0.28	1.00	0.91	1 1/16 - 14

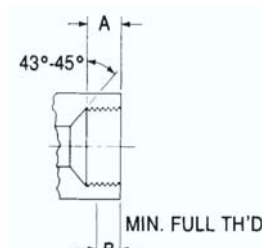

Internal Flare:

Size	A (in)	Min Rull Thread F (in)	Size Thread
3/16	0.28	0.22	3/8 - 24
1/4	0.34	0.27	7/16 - 20
5/16	0.38	0.30	1/2 - 20
3/8	0.44	0.34	5/8 - 18
1/2	0.53	0.44	3/4 - 16
5/8	0.66	0.55	7/8 - 14
3/4	0.78	0.67	1 1/16 - 14

45° Flare Fittings

Copper Flare Bonnets and Gaskets

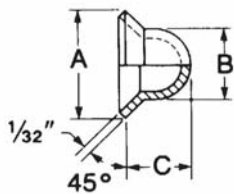

Copper Flare Seal Bonnets

Copper Flare Seal Bonnets

Cat Number	Part Number	Size Flare	A (in)	B (in)	C (in)*	Box Qty	Wt(lb)
B1-3	A 04737	3/16	0.31	0.16	0.16	25	0.001
B1-4	A 00414	1/4	0.36	0.22	0.22	100	0.001
B1-5	A 04935	5/16	0.42	0.28	0.28	50	0.004
B1-6	A 00415	3/8	0.55	0.36	0.34	100	0.005
B1-8	A 00416	1/2	0.66	0.47	0.41	100	0.005
B1-10	A 00485	5/8	0.77	0.61	0.44	20	0.010
B1-12	A 04738	3/4	0.95	0.72	0.56	25	0.015

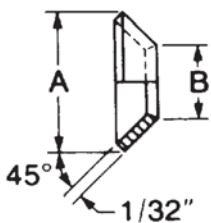

Copper Flare Gaskets

Copper Flare Gaskets

Cat Number	Part Number	Size Flare	A (in)	B (in)	C (in)*	Box Qty	Wt(lb)
B2-4	A 00401	1/4	0.36	0.19		100	0.001
B2-5	A 04811	5/16	0.42	0.22		50	0.017
B2-6	A 00402	3/8	0.55	0.28		100	0.002
B2-8	A 00403	1/2	0.66	0.41		100	0.002
B2-10	A 05186	5/8	0.77	0.50		50	0.005
B2-12	A 04822	3/4	0.95	0.63		25	0.005

* C Dimension: Copper Flare Seal Bonnet +/- 1/64

45° Flare Fittings

90° Elbows



Half Union - Flare to NPTFE

Cat Number	Part Number	Flare A (in)	B (in)	C (in)	D (in)	Box Qty	Wt(lb)
E1-4A	A 00335	1/4	1/8	0.94	0.78	25	0.040
E1-4B	A 04890	1/4	1/4	0.91	0.94	25	0.055
E1-4C	A 04812	1/4	3/8	0.94	1.03	25	0.082
E1-6A	A 04937	3/8	1/8	1.03	0.91	25	0.080
E1-6B	A 00337	3/8	1/4	1.06	1.06	25	0.077
E1-6C	A 04889	3/8	3/8	1.06	1.09	25	0.108
E1-6D	A 04886	3/8	1/2	1.13	1.34	25	0.160
E1-8B	A 05044	1/2	1/4	1.22	1.19	10	0.135
E1-8C	A 00339	1/2	3/8	1.22	1.13	15	0.140
E1-8D	A 04887	1/2	1/2	1.28	1.38	15	0.180
E1-8E	A 05072	1/2	3/4	1.34	1.38	10	0.231
E1-10C	A 04856	5/8	3/8	1.47	1.25	10	0.225
E1-10D	A 04538	5/8	1/2	1.47	1.44	10	0.240
E1-10E	A 05054	5/8	3/4	1.47	1.50	10	0.255

Union - Flare to Flare

Cat Number	Part Number	Flare A (in)	B (in)	C (in)	D (in)	Box Qty	Wt(lb)
E2-4	A 00147	1/4	1/4	0.91		25	0.074
E2-6	A 00146	3/8	3/8	1.06		25	0.095
E2-8	A 00145	1/2	1/2	1.22		15	0.150
E2-10	A 04539	5/8	5/8	1.47		10	0.250

External Flare to NPTFI

Cat Number	Part Number	Flare A (in)	B (in)	C (in)	D (in)	Box Qty	Wt(lb)
E3-4A	A 04630	1/4	1/8	0.91	0.91	25	0.050
E3-4B	A 05007	1/4	1/4	1.06	0.66	25	0.140

External Flare to Internal Flare

Cat Number	Part Number	Flare A (in)	B (in)	C (in)	D (in)	Box Qty	Wt(lb)	
E4-44	A 04898	*	1/4	1/4	0.94	0.88	25	0.065
E4-66	A 08082	*	3/8	3/8	1.22	1.06	25	0.170

Half Union - Flare to Solder

Cat Number	Part Number	Flare A (in)	B (in)	C (in)	D (in)	Box Qty	Wt(lb)
ES2-44	A 03449	1/4	1/4	0.84	0.36	25	0.035
ES2-66	A 03511	3/8	3/8	1.08	0.47	20	0.081
ES2-88	A 07851	1/2	1/2	1.22	0.47	10	0.120

External Flare to Internal Flare Swivel

Cat Number	Part Number	Flare A (in)	B (in)	C (in)	D (in)	Box Qty	Wt(lb)
ES4-44	A 15940	1/4	1/4	0.91	1.25	4	0.103
ES4-66	A 15941	3/8	3/8	1.08	1.42	4	0.133
ES4-88	A 15943	1/2	1/2	1.22	1.53	4	0.202

External Flare to Internal Flare Swivel, JIS Class II

Cat Number	Part Number	Flare A (in)	B (in)	C (in)	D (in)	Box Qty	Wt(lb)
	A 15940H	1/4	1/4	0.91	1.25	4	0.085
	A 15941H	3/8	3/8	1.08	1.42	4	0.085
	A 15943H	1/2	1/2	1.25	1.55	4	0.085

* Furnished Gasket

Half Union - Flare to NPTFE

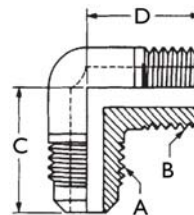

Union - Flare to Flare

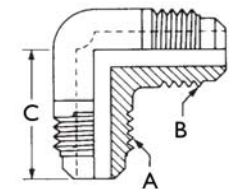

External Flare to NPTFI

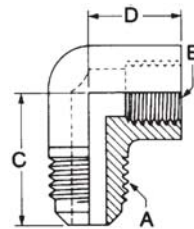

External FI to Internal FI

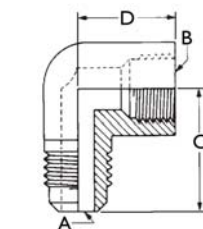

Half Union - Flare to Solder

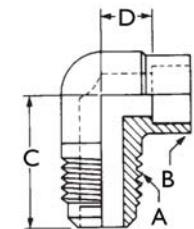

Ext FI to Int FI Swivel

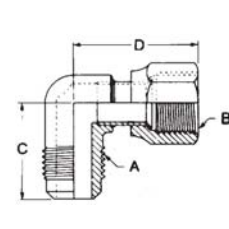

45° Flare Fittings

Adaptors

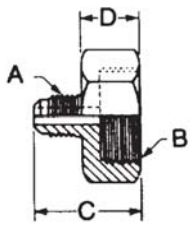

Refrigerant Drum Adapters									
Cat Number	Part Number	Flare A (in)	NPSM B (in) *	C (in)	D (in)	Hex	Box Qty	Wt(lb)	Replacement Gasket
K1-1	A 08073	1/4	3/4	1.13	0.44	1 1/4	10	0.159	A 08074
K1-3	A 08274	3/8	3/4	1.25	0.44	1 1/4	10	0.187	A 08074
K1-5	A 08276	1/2	3/4	1.38	0.44	1 1/4	10	0.194	A 08074
K1-8	A 08166	1/4	1/2	1.13	0.44	1 1/8	10	0.148	A 08167

* Furnished Gasket

45° Flare Fittings

Nuts

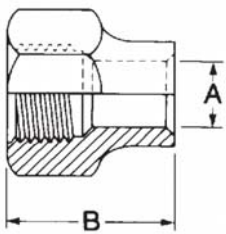

Long Forged Nuts

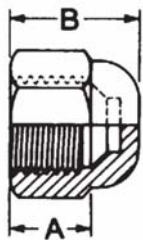

Flare Seal Cap

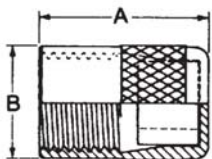

Flare Seal Cap
Finger Tightening

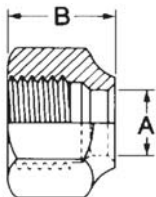

Short Forged

Long Forged Nuts

Cat Number	Part Number	Flare A (in)	Size Tube	Hex	A (in)	B (in)	Box Qty	Wt(lb)
N4-4	* A 00440	1/4	1/4	5/8	0.26	0.94	25	0.048
N4-6	* A 00441	3/8	3/8	13/16	0.38	1.06	25	0.075
N4-8	* A 00442	1/2	1/2	15/16	0.51	1.19	10	0.108
N4-10	* A 01112	5/8	5/8	1 1/16	0.63	1.44	5	0.185
N4-12	* A 04731	3/4	3/4	1 5/16	0.76	1.75	5	0.345

Flare Seal Caps

Cat Number	Part Number	Flare A (in)	Size Tube	Hex	A (in)	B (in)	Box Qty	Wt(lb)
N5-4	A 04544	1/4		9/16	0.34	0.56	50	0.025
N5-5	A 04758	5/16		5/8	0.38	0.56	25	0.027
N5-6	A 04545	3/8		3/4	0.44	0.69	25	0.045
N5-8	A 04546	1/2		7/8	0.55	0.81	25	0.069
N5-10	A 04560	5/8		1 1/16	0.63	0.94	10	0.137
N5-12	A 04951	3/4		1 5/16	0.75	1.09	10	0.210

Flare Seal Caps - Finger Tightening

Cat Number	Part Number	Flare A (in)	Size Tube	Hex	A (in)	B (in)	Box Qty	Wt(lb)
NFT5-4	A 16447	1/4			0.56	0.48	N/A	0.014
NFT5-6	A 16448	3/8			0.73	0.67	N/A	0.028

Short Forged Reducing Nuts

Cat Number	Part Number	Flare A (in)	Size Tube	Hex	A (in)	B (in)	Box Qty	Wt(lb)
NRS4-43	* A 05132	1/4	3/16	5/8	0.19	0.59	10	0.027
NRS4-54	* A 05247	5/16	1/4	11/16	0.26	0.63	10	0.055
NRS4-64	* A 05140	3/8	1/4	13/16	0.26	0.69	25	0.060
NRS4-65	* A 05282	3/8	5/16	13/16	0.32	0.69	10	0.027
NRS4-86	* A 05141	1/2	3/8	15/16	0.38	0.81	15	0.094
NRS4-108	* A 05228	5/8	1/2	1 1/16	0.51	0.94	15	0.125

Short Forged Nuts

Cat Number	Part Number	Flare A (in)	Size Tube	Hex	A (in)	B (in)	Box Qty	Wt(lb)
NS4-3	* A 05238	3/16	3/16	1/2	0.19	0.53	50	0.024
NS4-4	* A 05051	1/4	1/4	5/8	0.26	0.59	50	0.035
NS4-5	* A 05239	5/16	5/16	11/16	0.32	0.63	25	0.040
NS4-6	* A 05052	3/8	3/8	13/16	0.38	0.69	25	0.052
NS4-8	* A 05053	1/2	1/2	15/16	0.51	0.81	15	0.084
NS4-10	* A 05157	5/8	5/8	1 1/16	0.63	0.94	10	0.120
NS4-12	* A 05222	3/4	3/4	1 5/16	0.76	1.13	10	0.235

Short Forged Nuts, JIS Class II

Cat Number	Part Number	Flare A (in)	Size Tube	Hex	A (in)	B (in)	Box Qty	Wt(lb)
*	A 05051H	1/4	1/4	21/32	0.26	0.59	N/A	0.040
*	A 05052H	3/8	3/8	27/32	0.38	0.71	N/A	0.080
*	A 05053H	1/2	1/2	1 11/16	0.51	0.86	N/A	0.130
*	A 05157H	5/8	5/8	1 1/8	0.63	1.03	N/A	0.180
*	A 05222H	3/4	3/4	1 13/32	0.76	1.18	N/A	0.180

* UL File No. SA9003

45° Flare Fittings Plugs

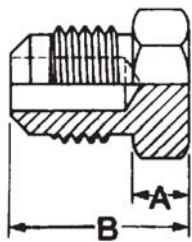

Flare Plug

Flare Plugs

Cat Number	Part Number	Flare A (in)	Hex	A (in)	B (in)	Box Qty	Wt(lb)
P2-3	A 05045	3/16	3/8	0.16	0.59	15	0.016
P2-4	A 00121	1/4	7/16	0.19	0.69	25	0.022
P2-5	A 00124	5/16	1/2	0.22	0.78	15	0.034
P2-6	A 00122	3/8	5/8	0.25	0.88	25	0.070
P2-8	A 00123	1/2	3/4	0.31	1.06	25	0.095
P2-10	A 04536	5/8	7/8	0.31	1.19	15	0.137
P2-12	A 04757	3/4	1 1/16	0.31	1.31	10	0.225

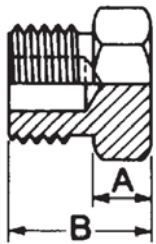

Brass Pipe Plug

Brass Pipe Plugs

Cat Number	Part Number	Flare A (in)	Hex	A (in)	B (in)	Box Qty	Wt(lb)
P3-A	A 00250	1/8	1/2	0.19	0.63	50	0.030
P3-B	A 00249	1/4	11/16	0.25	0.81	50	0.056
P3-C	A 00425	3/8	11/16	0.25	0.75	25	0.058
P3-D	A 04759	1/2	7/8	0.31	0.88	25	0.175
P3-E	A 05004	3/4	1 1/8	0.31	1.03	10	0.305

45° Flare Fittings

Tees

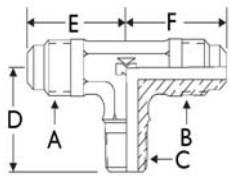

Two-Way

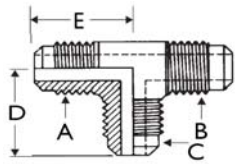

Three-Way

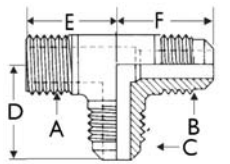

Right Angle Two-Way

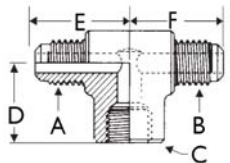

Three-Way, Internal Branch

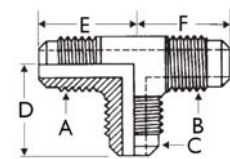

Three-Way Reducing

Two-Way

Cat Number	Part Number	A (in)	B (in)	C (in)	D (in)	E (in)	F (in)	Box Qty	Wt(lb)
		Flare	Flare	NPTFE					
T1-4A	A 00345	1/4	1/4	1/8	0.81	0.94	0.94	25	0.066
T1-4B	A 04859	1/4	1/4	1/4	1.03	0.91	0.91	25	0.080
T1-8C	A 00349	1/2	1/2	3/8	1.13	1.22	1.22	15	0.191

Three-Way

Cat Number	Part Number	A (in)	B (in)	C (in)	D (in)	E (in)	F (in)	Box Qty	Wt(lb)
		Flare	Flare	Flare					
T2-4	A 00340	1/4	1/4	1/4	0.94	0.94		25	0.065
T2-6	A 00342	3/8	3/8	3/8	1.06	1.06		15	0.143
T2-8	A 00344	1/2	1/2	1/2	1.22	1.22		15	0.196
T2-12	A 04749	3/4	3/4	3/4	1.66	1.66		5	0.502

Right Angle Two-Way

Cat Number	Part Number	A (in)	B (in)	C (in)	D (in)	E (in)	F (in)	Box Qty	Wt(lb)
		NPTFE	Flare	Flare					
T3-4A	A 00127	1/8	1/4	1/4	0.94	0.80	0.94	25	0.070
T3-4B	A 04998	1/4	1/4	1/4	0.94	1.06	0.94	25	0.088
T3-6C	A 04941	3/8	3/8	3/8	1.06	1.09	1.06	25	0.140
T3-8C	A 04778	3/8	1/2	1/2	1.22	1.13	1.22	15	0.182

Three-Way, Internal Branch

Cat Number	Part Number	A (in)	B (in)	C (in)	D (in)	E (in)	F (in)	Box Qty	Wt(lb)
		Flare	Flare	Flare					
T6-4	A 06330 *	1/4	1/4	1/4	0.94	0.91		25	0.085

Three-Way Reducing

Cat Number	Part Number	A (in)	B (in)	C (in)	D (in)	E (in)	F (in)	Box Qty	Wt(lb)
		Flare	Flare	NPTFE					
TR2-68	A 04547	3/8	3/8	1/2	1.22	1.13		15	0.194
TR2-86	A 04559	1/2	1/2	3/8	1.13	1.22		15	0.191

*Gasket Furnished

45° Flare Fittings Connectors

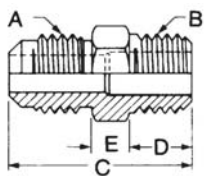

Half Union - Flare to NPTFE

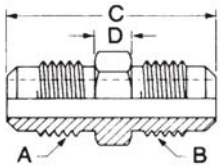

Union - Flare to Flare

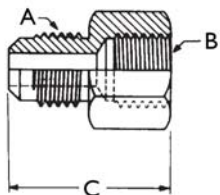

Half Union - Flare to NPTFI

Half Union - Flare to NPTFE

Cat Number	Part Number	A (in)	B (in)	C (in)	D (in)	E (in)	Hex	Box Qty	Wt(lb)
		Flare	NPTFE						
U1-3A	A 01117	3/16	1/8	1.00	0.38	0.19	7/16	15	0.025
U1-4A	A 00330	1/4	1/8	1.06	0.38	0.19	7/16	25	0.028
U1-4B	A 04585	1/4	1/4	1.25	0.56	0.19	9/16	25	0.047
U1-4C	A 01197	1/4	3/8	1.31	0.56	0.25	11/16	25	0.071
U1-4D	A 04628	1/4	1/2	1.56	0.75	0.31	7/8	25	0.114
U1-5A	A 00331	5/16	1/8	1.16	0.38	0.31	1/2	25	0.040
U1-5B	A 05036	5/16	1/4	1.34	0.56	0.22	9/16	25	0.055
U1-5C	A 01198	5/16	3/8	1.38	0.56	0.25	11/16	25	0.075
U1-6A	A 05003	3/8	1/8	1.25	0.38	0.25	5/8	25	0.065
U1-6B	A 00332	3/8	1/4	1.44	0.56	0.25	5/8	25	0.075
U1-6C	A 01199	3/8	3/8	1.44	0.56	0.25	11/16	25	0.090
U1-6D	A 04993	3/8	1/2	1.69	0.75	0.31	7/8	25	0.135
U1-8A	A 05034	1/2	1/8	1.44	0.38	0.31	3/4	10	0.094
U1-8B	A 04439	1/2	1/4	1.63	0.56	0.31	3/4	10	0.108
U1-8C	A 00334	1/2	3/8	1.63	0.56	0.31	3/4	10	0.119
U1-8D	A 04780	1/2	1/2	1.81	0.75	0.31	7/8	10	0.155
U1-8E	A 05066	1/2	3/4	1.94	0.75	0.44	1 1/16	10	0.228
U1-10B	A 05035	5/8	1/4	1.81	0.56	0.38	7/8	10	0.155
U1-10C	A 01195	5/8	3/8	1.81	0.56	0.38	7/8	10	0.168
U1-10D	A 04540	5/8	1/2	2.00	0.75	0.38	7/8	10	0.180
U1-10E	A 04827	5/8	3/4	2.06	0.75	0.44	1 1/16	5	0.250
U1-12C	A 05005	3/4	3/8	2.00	0.56	0.44	1 1/16	10	0.265
U1-12D	A 04739	3/4	1/2	2.19	0.75	0.44	1 1/16	5	0.286
U1-12E	A 04740	3/4	3/4	2.19	0.75	0.44	1 1/16	5	0.290

Unions - Flare to Flare

Cat Number	Part Number	A (in)	B (in)	C (in)	D (in)	E (in)	Hex	Box Qty	Wt(lb)
		Flare	Flare						
U2-4	A 00325	1/4	1/4	1.19	0.19		7/16	25	0.026
U2-5	A 00326	5/16	5/16	1.34	0.22		1/2	25	0.050
U2-6	A 00327	3/8	3/8	1.50	0.25		5/8	25	0.092
U2-8	A 00329	1/2	1/2	1.81	0.31		3/4	15	0.141
U2-10	A 04845	5/8	5/8	2.13	0.38		7/8	10	0.215
U2-12	A 04733	3/4	3/4	2.44	0.44		1 1/16	10	0.368

Half Union - Flare to NPTFI

Cat Number	Part Number	A (in)	B (in)	C (in)	D (in)	E (in)	Hex	Box Qty	Wt(lb)
		Flare	NPTFI						
U3-4A	A 04622	1/4	1/8	1.03			9/16	25	0.042
U3-4B	A 04625	1/4	1/4	1.25			11/16	25	0.065
U3-4C	A 04961	1/4	3/8	1.28			13/16	15	0.081
U3-6A	A 04927	3/8	1/8	1.13			5/8	10	0.065
U3-6B	A 04624	3/8	1/4	1.31			11/16	25	0.083
U3-6C	A 04627	3/8	3/8	1.38			13/16	15	0.100
U3-6D	A 08104	3/8	1/2	1.63			1	15	0.163
U3-8B	A 04928	1/2	1/4	1.41			3/4	15	0.112
U3-8C	A 04727	1/2	3/8	1.50			13/16	15	0.115
U3-8D	A 04728	1/2	1/2	1.75			1	15	0.181
U3-10C	A 04929	5/8	3/8	1.59			7/8	10	0.160
U3-10D	A 04819	5/8	1/2	1.81			1	10	0.195
U3-10E	A 04977	5/8	3/4	1.91			1 1/4	10	0.286

* 2 Gaskets Furnished

45° Flare Fittings

Connectors

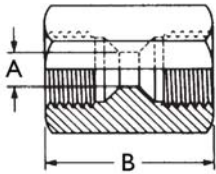

Internal Flare Union

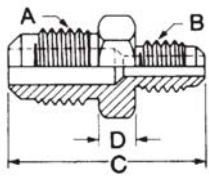

Reducing Unions - FI to FI

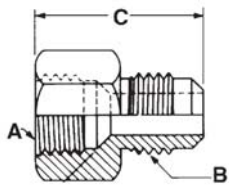

Internal FI to External FI

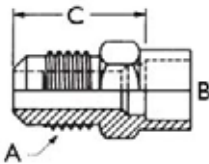

Half Union - Ext FI to Solder

Internal Flare Unions

Cat Number	Part Number	A (in)	B (in)	C (in)	D (in)	E (in)	Hex	Box Qty	Wt(lb)
Flare									
U4-4	A 00385	*	1/4	1.00			5/8	10	0.065
U4-6	A 00386	*	3/8	1.25			13/16	10	0.118
U4-8	A 00387	*	1/2	1.44			15/16	10	0.175

Reducing Unions - Flare to Flare

Cat Number	Part Number	A (in)	B (in)	C (in)	D (in)	E (in)	Hex	Box Qty	Wt(lb)
Flare Flare									
UR2-43	A 05270	1/4	3/16	1.13	0.19		7/16	15	0.030
UR2-54	A 08730	5/16	1/4	1.28	0.22		1/2	10	0.046
UR2-64	A 01171	3/8	1/4	1.38	0.25		5/8	15	0.072
UR2-65	A 04981	3/8	5/16	1.44	0.25		5/8	10	0.078
UR2-84	A 00356	1/2	1/4	1.56	0.31		3/4	15	0.100
UR2-86	A 00149	1/2	3/8	1.69	0.31		3/4	25	0.127
UR2-106	A 05334	5/8	3/8	1.88	0.38		7/8	10	0.175
UR2-108	A 04846	5/8	1/2	2.00	0.38		7/8	15	0.192
UR2-128	A 04734	3/4	1/2	2.19	0.44		1 1/16	10	0.290
UR2-1210	A 04784	3/4	5/8	2.31	0.44		1 1/16	10	0.332

Internal Flare to External Flare

Cat Number	Part Number	A (in)	B (in)	C (in)	D (in)	E (in)	Hex	Box Qty	Wt(lb)
Flare Flare									
UR3-43	A 05147	1/4	3/16	1.03			5/8	10	0.047
UR3-46	A 05041	1/4	3/8	1.13			5/8	15	0.070
UR3-48	A 08127	1/4	1/2	1.25			3/4	10	0.112
UR3-64	A 00479	3/8	1/4	1.22			13/16	15	0.078
UR3-68	A 04888	3/8	1/2	1.41			13/16	15	0.110
UR3-84	A 00480	1/2	1/4	1.38			15/16	15	0.107
UR3-86	A 00481	1/2	3/8	1.44			15/16	15	0.120
UR3-108	A 04770	5/8	1/2	1.69			1 1/16	10	0.180
UR3-810	A 04879	1/2	5/8	1.63			15/16	10	0.169
UR3-1012	A 04878	5/8	3/4	1.91			1 1/16	10	0.265
UR3-1210	A 04826	3/4	5/8	1.97			1 5/16	10	0.241

Half Union - External Flare to Solder

Cat Number	Part Number	A (in)	B (in)	C (in)	D (in)	E (in)	Hex	Box Qty	Wt(lb)
Flare OD									
US3-44	A 03431	1/4	1/4	0.69			7/16	50	0.025
US3-45	A 03466	1/4	5/16	0.69			7/16	25	0.023
US3-46	A 03494	1/4	3/8	0.69			1/2	25	0.029
US3-64	A 03443	3/8	1/4	0.88			5/8	25	0.070
US3-65	A 03464	3/8	5/16	0.88			5/8	25	0.061
US3-66	A 03492	3/8	3/8	0.88			5/8	25	0.063
US3-68	A 03547	3/8	1/2	0.88			5/8	10	0.062
US3-86	A 03504	1/2	3/8	1.06			3/4	25	0.112
US3-88	A 03546	1/2	1/2	1.06			3/4	15	0.096
US3-108	A 03519	5/8	1/2	1.25			7/8	10	0.160
US3-610	A 06601	3/8	5/8	0.88			3/4	10	0.075
US3-810	A 02259	1/2	5/8	1.06			3/4	10	0.100
US3-1010	A 02258	5/8	5/8	1.25			7/8	10	0.155
US3-1012	A 02272	5/8	3/4	1.25			7/8	10	0.150
US3-1014	A 02378	5/8	7/8	1.25			1	10	0.166
US3-1212	A 05307	3/4	3/4	1.44			1 1/16	5	0.246
US3-1214	A 05425	3/4	7/8	1.31			1 1/16	5	0.249

* 2 Gaskets Furnished

45° Flare Fittings Connectors

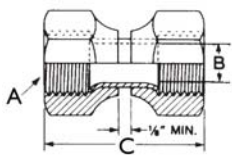

Internal FI Swivel Unions

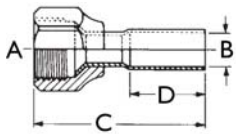

Internal FI to Extension Solder

Internal Flare Swivel Unions

Cat Number	Part Number	A (in)	B (in)	C (in)	D (in)	E (in)	Hex	Box Qty	Wt(lb)
		Flare							
US4-4	A 13563	1/4	0.19	1.38			5/8	15	0.353
US4-5	A 13564	5/16	0.25	1.44			11/16	15	0.085
US4-6	A 13565	3/8	0.31	1.56			13/16	15	0.120
US4-8	A 13567	1/2	0.44	1.81			15/16	15	0.175
US4-10	A 13568	5/8	0.56	2.06			1 1/16	15	0.255

Internal Flare Swivel Unions, JIS Class II

Cat Number	Part Number	A (in)	B (in)	C (in)	D (in)	E (in)	Hex	Box Qty	Wt(lb)
		Female Flare		OD					
	A 13563H	1/4	0.19	1.38			5/8	15	0.091
	A 13565H	3/8	0.31	1.56			13/16	15	0.176
	A 13567H	1/2	0.44	1.81			15/16	15	0.290
	A 13568H	5/8	0.56	2.06			1 1/16	15	0.409

Internal Flare to Extension Solder

Cat Number	Part Number	A (in)	B (in)	C (in)	D (in)	E (in)	Hex	Box Qty	Wt(lb)
US5-44	A 15725	1/4	1/4	1.60	0.81		5/8	25	0.043
US5-66	A 15726	3/8	3/8	1.71	0.81		13/16	25	0.070
US5-88	A 15727	1/2	1/2	1.98	0.88		15/16	20	0.104
US5-1010	A 15728	5/8	5/8	2.29	1.00		1 1/16	10	0.155
US5-1212	A 15729	3/4	3/4	2.85	1.25		1 5/16	10	0.310

Internal Flare to Extension Solder, JIS Class II

Cat Number	Part Number	A (in)	B (in)	C (in)	D (in)	E (in)	Hex	Box Qty	Wt(lb)
		Female Flare		ODS					
	A 15725H	1/4	1/4	1.60	0.81		5/8	25	0.050
	A 15726H	3/8	3/8	1.71	0.81		13/16	20	0.098
	A 15727H	1/2	1/2	1.98	0.88		15/16	20	0.157
	A 15728H	5/8	5/8	2.29	1.00		1 1/16	10	0.215
	A 15729H	3/4	3/4	2.85	1.25		1 5/16	10	0.050

Forged Brass Solder Flanges And Gaskets



2 Bolt-Hole

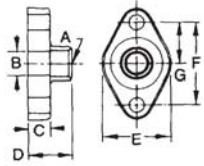

2 Bolt, Serrated Gasket Surface

Flange with Serrated Gasket Surface

Part Number	A (in)	B (in)	C (in)	D (in)	E (in)	F (in) Bolt Hole Centers	G (in)	H (in)	Dia Bolt Holes	Box Qty	Wt (lb)	Gasket
A 08314	5/8	9/16	0.75	1.19	1.50	1 5/8	0.81		11/32	1	0.45	
A 05299	3/4	11/16	0.75	1.31	1.50	1 5/8	0.81		3/8	1	0.42	
A 09215	7/8	13/16	0.75	1.44	1.50	1 5/8	0.81		11/32	1	0.40	
A 08315	7/8	13/16	0.75	1.44	2.25	2 3/4	1.38		17/32	1	1.08	
A 05151	1 1/8	1 1/16	0.75	1.56	2.25	2 3/4	1.38		17/32	1	1.11	
A 05074	1 3/8	1 19/64	0.75	1.53	2.25	2 3/4	1.38		17/32	1	0.90	

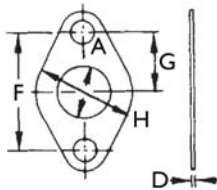

2 Bolt Gasket, Asbestos-Free

Gasket, Asbestos-Free Material

Part Number	A (in)	B (in)	C (in)	D (in)	E (in)	F (in) Bolt Hole Centers	G (in)	H (in)	Dia Bolt Holes	Box Qty	Wt (lb)	Gasket
A 04582	9/16			0.03		1 5/8	0.81	1.13	11/32	N/A	0.00	
N 02308	13/16			0.03		1 5/8	0.81	1.50	11/32	N/A	0.00	
N 02307	13/16			0.03		1 3/4	0.88	1.50	11/32	N/A	0.00	
A 05152	13/16			0.06		2 3/4	1.38	2.25	17/32	20	0.02	

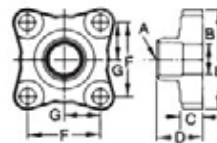

4 Bolt, Flat Gasket Surface

4 Bolt-Hole

Flange with Flat Gasket Surface

Part Number	A (in)	B (in)	C (in)	D (in)	E (in)	F (in) Bolt Hole Centers	G (in)	H (in)	Dia Bolt Holes	Box Qty	Wt (lb)	Gasket
A 08624	1 1/8	1 1/16	0.75	1.56	3.41	2.50	1.25		17/32	1	1.93	A 08628
A 08625	1 3/8	1 19/64	0.75	1.63	3.41	2.50	1.25		17/32	1	1.88	A 08628
A 08626	1 5/8	1 17/32	0.75	1.75	3.41	2.50	1.25		17/32	1	1.73	A 08628
A 08627	2 1/8	1 15/16	0.75	1.72	3.41	2.50	1.25		17/32	1	1.47	A 08628

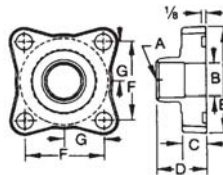

4 Bolt, Groove Diameters
2 25/32" x 2 1/16"

Flange with Groove Diameters 2 25/32" x 2 1/16"

Part Number	A (in)	B (in)	C (in)	D (in)	E (in)	F (in) Bolt Hole Centers	G (in)	H (in)	Dia Bolt Holes	Box Qty	Wt (lb)	Gasket
A 08630	1 1/8	1 1/16	0.75	1.56	3.41	2.50	1.25		17/32	1	1.81	A 08634
A 08631	1 3/8	1 19/64	0.75	1.63	3.41	2.50	1.25		17/32	1	1.75	A 08634
A 08261	1 5/8	1 17/32	0.75	1.75	3.41	2.50	1.25		17/32	1	1.64	A 08634
A 08633	2 1/8	1 15/16	0.75	1.72	3.41	2.50	1.25		17/32	1	1.42	A 08634

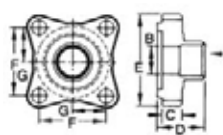

4 Bolt, Flat, Tongue, Groove
Diameters 2 3/4" x 2 3/16"

Flange with Tongue, Groove Diameters 2 3/4" x 2 3/16"

Part Number	A (in)	B (in)	C (in)	D (in)	E (in)	F (in) Bolt Hole Centers	G (in)	H (in)	Dia Bolt Holes	Box Qty	Wt (lb)	Gasket
A 08629	1 1/8	1 1/16	0.75	1.72	3.41	2.50	1.25		17/32	1	2.00	A 08634
A 05150	1 3/8	1 19/64	0.75	1.78	3.41	2.50	1.25		17/32	1	1.98	A 08634
A 05148	1 5/8	1 17/32	0.75	1.91	3.41	2.50	1.25		17/32	1	1.87	A 08634
A 08632	2 1/8	1 15/16	0.75	1.88	3.41	2.50	1.25		17/32	1	1.59	A 08634

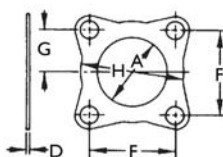

4 Bolt Gasket, Asbestos-Free

Gasket, Asbestos-Free Material

Part Number	A (in)	B (in)	C (in)	D (in)	E (in)	F (in) Bolt Hole Centers	G (in)	H (in)	Dia Bolt Holes	Box Qty	Wt (lb)	Gasket
A 08628	2 1/16			0.03		2.50	1.25	3	9/16	N/A	0.01	

Component Parts

Seal Caps and Gaskets

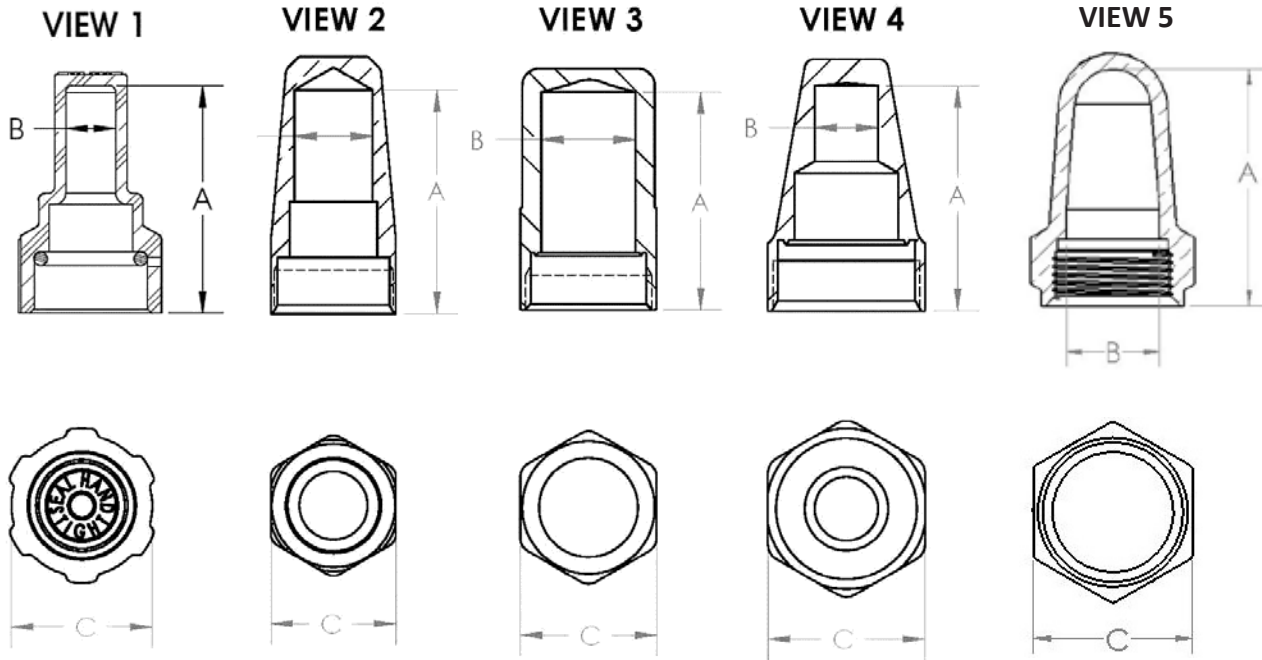

Seal Cap	Gasket	Seal Cap Ki	Thread Size	Material	View	A	B	C
P 34627	NA	NA	3/4" - 16	Nylon	1	1.73	0.35	0.95
A 04566	NA	NA	3/4" - 16	Steel	3	1.3	0.56	0.81
A 04597	A 03468	A 16474	3/4" - 16	Brass	3	1.24	0.56	0.81
S 36284	A 03468	A 18725	3/4" - 16	Brass	3	1.71	0.56	0.81
A 00409	NA	NA	7/8" - 18	Steel	4	1.34	0.38	0.93
P 34632	NA	NA	1 1/16" - 18	Valox	1	2.05	0.45	1.26
A 04775	A 04710	A 15099	1 1/16" - 18	Brass	2	2	0.7	1.13
S 35923	A 04710	NA	1 1/16" - 18	Brass	2	2.48	0.7	1.13
P 37717	P 37718	A 19040	11/16" - 20 Modified	Brass	5	1.35	0.53	0.81

Competitive Cross Reference

Ball Valves

CYCLEMASTER® Ball Valves

Standard

Size	Mueller	Kit with Insulation	Danfoss	Emerson	Henry	Parker	Superior HVACR	Kit with Insulation
1/4	AP17859		009G7020	BVE014		EBV-1020	586WA-4ST	
3/8	AP17860C		009G7021	BVE038		EBV-1030	586WA-6ST	
1/2	AP17861C		009G7022	BVE012		EBV-1040	586WA-8ST	
5/8	AP17862C		009G7023	BVE058		EBV-1050	586WA-10ST	
3/4	AP17863		009G7024	BVE034		EBV-1060	587WA-12ST	
7/8	AP17864C		009G7025	BVE078		EBV-1070	587WA-14ST	
1 1/8	AP17865		009G7026	BVE118		EBV-1090	591WA-11ST	
1 3/8	A 17866		009G7027	BVE138		EBV-1110	592WA-13ST	
1 5/8	A 17867		009G7028	BVE158		EBV-1130	593WA-15ST	
2 1/8	A 17868		009G7029	BVE218		EBV-1170	594WA-21ST	
2 5/8	A 17869		009G7959			EBV-1210	595WA-25ST	
3 1/8	A 17870		009G7980			EBV-1250	596WA-31ST	
2 5/8	A 17871		009G7036	BVE258		EBV-2210	594WA-25ST	
3 1/8	A 17872		009G7037	BVE318		EBV-2250	594WA-31ST	

CYCLEMASTER® Ball Valves

Standard With Access Port

Size	Mueller	Kit with Insulation	Danfoss	Emerson	Henry	Parker	Superior HVACR	Kit with Insulation
1/4	AQ17859		009G7050	BVS014		EBVT-1020		
3/8	AQ17860C		009G7051	BVS038	937202	EBVT-1030	586WAS-6ST	
1/2	AQ17861C		009G7052	BVS012	937203	EBVT-1040	586WAS-8ST	
5/8	AQ17862C		009G7053	BVS058	937204	EBVT-1050	586WAS-10ST	
3/4	AQ17863		009G7054	BVS034		EBVT-1060	587WAS-12ST	
7/8	AQ17864C		009G7055	BVS078	937205	EBVT-1070	587WAS-14ST	
1 1/8	AQ17865		009G7056	BVS118	937307	EBVT-1090	591WAS-11ST	
1 3/8	AC17866		009G7057	BVS138	937409	EBVT-1110	592WAS-13ST	
1 5/8	AC17867		009G7058	BVS158	937511	EBVT-1130	593WAS-15ST	
2 1/8	AC17868		009G7059	BVS218		EBVT-1170	594WAS-21ST	
2 5/8	AC17869		009G7960			EBVT-1210	595WAS-25ST	
3 1/8	AC17870		009G7981			EBVT-1250	596WAS-31ST	
2 5/8	AC17871		009G7066	BVS258		EBVT-2210	594WAS-25ST	
3 1/8	AC17872		009G7067	BVS318		EBVT-2250	594WAS-31ST	

Multi Split Ball Valves

Unibody Female x Male Flare

Size	Mueller	Kit with Insulation	Danfoss	Emerson	Henry	Parker	Superior HVACR	Kit with Insulation
1/4	A 18945	A 18567U					586WBS-4FL	586WBS-4FLSP
3/8	A 18946	A 18568U					586WBS-6FL	586WBS-6FLSP
1/2	A 18947	A 18569U					586WBS-8FL	586WBS-8FLSP
5/8	A 18948	A 18570U					586WBS-10FL	586WBS-10FLSP
3/8 F X 1/4 M	A 18949	A 18652U					586WBS-6MX4F-FL	586WBS-6MX4F-FLSP
5/8 F X 1/2 M	A 18950	A 18653U					586WBS-10MX8F-FL	586WBS-10MX8F-FLSP

Multi Split Ball Valves

Unibody ODS x ODS

Size	Mueller	Kit with Insulation	Danfoss	Emerson	Henry	Parker	Superior HVACR	Kit with Insulation
1/4	A 18937	A 18571U					586WBS-4SW	586WBS-4SWSP
3/8	A 18938	A 18572U					586WBS-6SW	586WBS-6SWSP
1/2	A 18939	A 18573U					586WBS-8SW	586WBS-8SWSP
5/8	A 18940	A 18574U					586WBS-10SW	586WBS-10SWSP

CYCLEMASTER® Ball Valves

Insulation Cover

Size	Mueller	Kit with Insulation	Danfoss	Emerson	Henry	Parker	Superior HVACR	Kit with Insulation
Holes Offset	MSBVINS						P586WAS-FOAMSP	

Competitive Cross Reference

Check Valves

Check Valves

90° Angle									
Size	Inlet	Outlet	Mueller	Universal	Danfoss	Emerson	Henry	Parker	Superior HVACR
7/8			A 18566C		020-1020				
1 1/8			A 18659C		020-1021				
1 3/8			A 18660C		020-1026				

Check Valves

Flare to Flare									
Size	Inlet	Outlet	Mueller	Universal	Danfoss	Emerson	Henry	Parker	Superior HVACR
1/4			A 15620		020-1040		119-1/4		802B-4
3/8			A 15621		020-1041		119-3/8		802B-6
1/2			A 15622		020-1042		119-1/2		802B-8
5/8			A 15623		020-1043		119-5/8		802B-10

Check Valves

Solder to Solder									
Size	Inlet	Outlet	Mueller	Universal	Danfoss	Emerson	Henry	Parker	Superior HVACR
3/8			A 15629				116003		
1/2			A 15630				116004		
5/8			A 15631				116005		
1/4			A 15632		020-1010		120-1/4		
3/8			A 15633		020-1011		120-3/8		
1/2			A 15634		020-1012		120-1/2		
5/8			A 15635		020-1018		120-5/8		

Check Valves

Magnetic									
Size	Inlet	Outlet	Mueller	Universal	Danfoss	Emerson	Henry	Parker	Superior HVACR
1/4			A 17934			ACK-4			900MA-4S
3/8			A 17935			ACK-6			900MA-6S
1/2			A 17936			ACK-8			900MA-8S
5/8			A 17937			ACK-10			900MA-10S
3/4			A 17938			ACK-12			900MA-12S
7/8			A 17939			ACK-14			900MA-14S
1 1/8			A 17940			ACK-18			900MA-11S
1 3/8			A 17941			ACK-22			900MA-13S
1 5/8			A 17942			ACK-26			900MA-15S
2 1/8			A 17943			ACK-34			900MA-21S
2 5/8			A 17944			ACK-42			900MA-25S

Check Valves

Four-Bolt									
Size	Inlet	Outlet	Mueller	Universal	Danfoss	Emerson	Henry	Parker	Superior HVACR
7/8			B 34235						805C-14S
1 1/8			B 34236						806C-11S
1 3/8			B 34237						807C-13S
1 5/8			B 34238						808C-15S
2 1/8			B 34239						809C-21S
2 5/8			B 34240						884C-25S
3 1/8			B 34241						885C-31S

Competitive Cross Reference

Line Valves

Packed Line Valves, Angle

Backseating NPTFE Inlet to Flare

Size	Inlet	Outlet	Mueller	Universal	Danfoss	Emerson	Henry	Parker	Superior HVACR
1/2			A 13220						605-8D
1/2			A 13183						606B-10D

Packed Line Valves, Angle

Backseating NPTFE Inlet to Solder

Size	Inlet	Outlet	Mueller	Universal	Danfoss	Emerson	Henry	Parker	Superior HVACR
1/2			A 13978						605-10S
3/4			A 13979						607-14S

Packed Line Valves, Angle

Non-Backseating Internal Swivel Flare to Flare

Size	Inlet	Outlet	Mueller	Universal	Danfoss	Emerson	Henry	Parker	Superior HVACR
1/4			A 17429						600B-4U4
3/8			A 17474						600B-6U6

Packed Line Valves, Angle

Non-Backseating NPTFE Inlet to Flare

Size	Inlet	Outlet	Mueller	Universal	Danfoss	Emerson	Henry	Parker	Superior HVACR
1/4			A 11031				7761-B		600A-4B
1/4			A 11030				7763-B		600A-6B
3/8			A 13613				7764-B		600A-4C
3/8			A 13503				7766-B		600A-6C
3/8			A 11042				7767-B		605-8C
1/2			A 19023						605-6D

Packed Line Valves, Angle

Non-Backseating Solder to Flare

Size	Inlet	Outlet	Mueller	Universal	Danfoss	Emerson	Henry	Parker	Superior HVACR
1/4			A 17502						617A-4S4
3/8			A 17503						617A-6S6
1/2			A 19022						617A-8S4
1/2			A 19021						617A-8S6
3/8			A 17913				9271		617A-6S4

Packed Line Valves, Angle

Non-Backseating, NPTFE x NPTFI, NPTFI x NPTFE

Size	Inlet	Outlet	Mueller	Universal	Danfoss	Emerson	Henry	Parker	Superior HVACR
1/4			A 13502				7771-B		600A-B4

Transducer Valves

NPTFI X NPTFE

Size	Inlet	Outlet	Mueller	Universal	Danfoss	Emerson	Henry	Parker	Superior HVACR
			B 33837						600AX7-JB

Competitive Cross Reference

Diaphragm Valves

Packless Diaphragm Valves

Angle, NPTFE to Flare

Size	Inlet	Outlet	Mueller	Universal	Danfoss	Emerson	Henry	Parker	Superior HVACR
1/4			A 15525						114-4B
1/4			A 15526						114-4C
3/8			A 15527						114-6B
3/8			A 15528						114-6C
1/2			A 15530						115-8C
1/2			A 15531						116-10D

Packless Diaphragm Valves

Angle, Solder to Solder

Size	Inlet	Outlet	Mueller	Universal	Danfoss	Emerson	Henry	Parker	Superior HVACR
1/4			A 15539				5461		114-4S
1/2			A 15541				5464		115-8S
5/8			A 15542						116-10S

Packless Diaphragm Valves

Straight, Flare to Flare

Size	Inlet	Outlet	Mueller	Universal	Danfoss	Emerson	Henry	Parker	Superior HVACR
1/4			A 14833				5151		214-4
3/8			A 14835				5153		214-6
1/2			A 14836				5154		215-8
5/8			A 14837				5155		216-10

Packless Diaphragm Valves

Straight Purge and Drain

Size	Inlet	Outlet	Mueller	Universal	Danfoss	Emerson	Henry	Parker	Superior HVACR
3/8			A 18997						234A-6
1/4			A 18998						234A-4

Packless Diaphragm Valves

Straight, Solder to Solder

Size	Inlet	Outlet	Mueller	Universal	Danfoss	Emerson	Henry	Parker	Superior HVACR
1/4			A 14838				5160		214-4S
3/8			A 14840				5163		214-6S
1/2			A 14841				5164		215-8S
5/8			A 14842				5165		216-10S

Packless Diaphragm Valves

Straight, Solder to Solder Extended Ends

Size	Inlet	Outlet	Mueller	Universal	Danfoss	Emerson	Henry	Parker	Superior HVACR
1/4			A 14848				5171		214-4ST
3/8			A 14850C						214-6ST
1/2			A 14851				5174		215-8ST
5/8			A 14852				5175		216-10ST

Competitive Cross Reference

Pressure Relief Valves

Pressure Relief Valves

Angle NPTFE to Flare

Size	Inlet	Outlet	Mueller	Universal	Danfoss	Emerson	Henry	Parker	Superior HVACR	
	1/4	3/8	B 33746				526EA		3212	3212C
	3/8	3/8	A 15512				526E		3214	3214C
	3/8	1/2	A 15513				526EB		3215	3215C
	1/2	5/8	A 15514				527E		3220	3220C
	3/8	1/2	A 18784						3216	3216C

Pressure Relief Valves

Atmospheric - NPTFE Inlet

Size	Inlet	Outlet	Mueller	Universal	Danfoss	Emerson	Henry	Parker	Superior HVACR	
	1/8		A 15508				5220		3000	3000C
	1/4		A 15509				5221		3001	3001C
	3/8		A 17430				5223		3002	3002C
	1/4		B 33755						3001	3001C

Pressure Relief Valves

Straight Thru - NPTFE Inlet to Flare Outlet

Size	Inlet	Outlet	Mueller	Universal	Danfoss	Emerson	Henry	Parker	Superior HVACR	
	1/4	3/8	A 15501				5230		3012	3012C
	3/8	3/8	A 15502				5231		3014	3014C
	3/8	1/2	A 15503				5231-A		3015	3015C
	1/2	5/8	A 15504				5232		3020	3020C
	1/4	3/8	B 33752				5230		3012	3012C
	3/8	5/8	A 18737				5233A			
	3/8	1/2	A 18783						3016	3016C

Pressure Relief Valves

Straight Thru - NPTFE Inlet to NPTFI Outlet

Size	Inlet	Outlet	Mueller	Universal	Danfoss	Emerson	Henry	Parker	Superior HVACR	
	1/2	1/2	A 18356				5232B		3030	3030C
	1/2	3/4	A 18357				5235A		3031	3031C
	3/4	3/4	A 15506						3045	3045C
	3/4	3/4	A 18358						3045	3045C
	1	1	A 18387						3060	3060C
	1 1/4	1 1/4	A 17834						3075	3075C
	3/8	3/4	A 18736				5234A			
	1/2	3/4	A 18762				5235A			
	3/4	1	A 18735				5244-3/4			

Competitive Cross Reference

Liquid Line Filter Driers

DRYMASTER® Filter Driers

Liquid Line Flare

Size	Dess. Cu In	Mueller	Mueller High Capacity	Universal	Danfoss	Emerson	Henry	Parker	Sanhua
1/4	3	A 16600	A 18184	FL-032		EK-032	H032	C-032	
3/8	3	A 16601	A 18185	FL-033		EK-033	H033	C-033	
1/4	5	A 16606	A 18186	FL-052		EK-352	H352	C-052	
3/8	5	A 16607	A 18187	FL-053		EK-053	H053	C-053	
1/4	8	A 16608	A 18188	FL-082		EK-082	H082	C-082	
3/8	8	A 16609	A 18189	FL-083		EK-083	H083	C-083	
1/2	8	A 16610	A 18190	FL-084		EK-084	H084	C-084	
1/4	16	A 16612	A 18191	FL-162		EK-162	H162	C-162	
3/8	16	A 16613	A 18192	FL-163		EK-163	H163	C-163	
1/2	16	A 16614	A 18193	FL-164		EK-164	H164	C-164	
5/8	16	A 16615	A 18194	FL-165		EK-165	H165	C-165	
3/8	30	A 16618	A 18195	FL-303		EK-303	H303	C-303	
1/2	30	A 16619	A 18196	FL-304		EK-304	H304	C-304	
5/8	30	A 16620	A 18197	FL-305		EK-305	H305	C-305	
3/8	41	A 16623	A 18198	FL-413		EK-413	H413	C-413	
1/2	41	A 16624	A 18199	FL-414		EK-414	H414	C-414	
5/8	41	A 16625	A 18200	FL-415		EK-415	H415	C-415	

DRYMASTER® Filter Driers

Liquid Line Solder

Size	Dess. Cu In	Mueller	Mueller High Capacity	Universal	Danfoss	Emerson	Henry	Parker	Sanhua
1/4	3	A 16640	A 18598	SD-032	DCL-032S	EK-032S	SDM-032S	C-032-S	STG-F03 020-9
3/8	3	A 16641	A 18599	SD-033	DCL-033S	EK-033S	SDM-033S	C-033-S	STG-F03 030-9
1/4	5	A 16646	A 18654	SD-052	DCL-052S	EK-052S	SDM-052S	C-052-S	STG-F05 020-9
3/8	5	A 16647	A 18655	SD-053	DCL-053S	EK-053S	SDM-053S	C-053-S	STG-F05 030-9
1/4	8	A 16648	A 18656	SD-082	DCL-082S	EK-082S	SDM-082S	C-082-S	STG-F08 020-9
3/8	8	A 16649	A 18657	SD-083	DCL-083S	EK-083S	SDM-083S	C-083-S	STG-F08 030-9
1/2	8	A 16650	A 18658	SD-084	DCL-084S	EK-084S	SDM-084S	C-084-S	STG-F08 040-9
3/8	16	A 16653	A 18699	SD-163	DCL-163S	EK-163S	SDM-163S	C-163-S	STG-F16 030-9
1/2	16	A 16654	A 18700	SD-164	DCL-164S	EK-164S	SDM-164S	C-164-S	STG-F16 040-9
5/8	16	A 16655	A 18701	SD-165	DCL-165S	EK-165S	SDM-165S	C-165-S	STG-F16 050-9
3/4	16	A 16657	A 18702	SD-166	DCL-166S	EK-166S			
7/8	16	A 16656	A 18703	SD-167	DCL-167S	EK-167S	SDM-167S	C-167-S	STG-F16 070-9
3/8	30	A 16658	A 18741	SD-303	DCL-303S	EK-303S	SDM-303S	C-303-S	STG-F30 030-9
1/2	30	A 16659	A 18742	SD-304	DCL-304S	EK-304S	SDM-304S	C-304-S	STG-F30 040-9
5/8	30	A 16660	A 18743	SD-305	DCL-305S	EK-305S	SDM-305S	C-305-S	STG-F30 050-9
7/8	30	A 16662	A 18744	SD-307	DCL-307S	EK-307S	SDM-307S	C-307-S	STG-F30 070-9
1 1/8	30	A 16661	A 18745	SD-309	DCL-309S	EK-309S	SDM-309S		STG-F30 090-9
3/8	41	A 16663	A 18746	SD-413			SDM-413S		
1/2	41	A 16664	A 18747	SD-414	DCL-414S	EK-414S	SDM-414S	C-414-S	
5/8	41	A 16665	A 18748	SD-415	DCL-415S	EK-415S	SDM-415S	C-415-S	
7/8	41	A 16667	A 18749	SD-417	DCL-417S	EK-417S	SDM-417S	C-417-S	
1 1/8	41	A 16668	A 18823	SD-419	DCL-419S	EK-419S	SDM-419S	C-419-S	

Competitive Cross Reference

Suction Line and Heat Pump Driers

DRYMASTER® Filter Driers

Suction Line Flare

Size	Dess. Cu In	Mueller	Mueller High Capacity	Universal	Danfoss	Emerson	Henry	Parker
1/2	16	A 17225		FDF-164-TT				
5/8	16	A 17226		FDF-165-TT				

DRYMASTER® Filter Driers

Suction Line Solder

Size	Dess. Cu In	Mueller	Mueller High Capacity	Universal	Danfoss	Emerson	Henry	Parker
1/2	16	A 17224		FDS-164-TT	DAS 164SVV	SFD 13S4-W		
5/8	16	A 17227		FDS-165-TT	DAS 165SVV	SFD 13S5-W	SDAS-165S	
3/4	16	A 17228		FDS-166-TT	DAS 166SVV	SFD 13S6-W	SDAS-166S	
7/8	16	A 17229		FDS-167-TT	DAS 167SVV	SFD 13S7-W	SDAS-167S	
1 1/8	16	A 17230		FDS-169-TT				
5/8	30	A 17300		FDS-305-TT	DAS 305SVV		SDAS-305S	
3/4	30	A 17301		FDS-306-TT	DAS 306SVV	SFD 27S6-W	SDAS-306S	
7/8	30	A 17302		FDS-307-TT	DAS 307SVV	SFD 27S7-W	SDAS-307S	
1 1/8	30	A 17231		FDS-309-TT	DAS 309SVV	SFD 27S9-W	SDAS-309S	

DRYMASTER® Heat Pump Driers

Flare Connection

Size	Dess. Cu In	Mueller	Mueller High Capacity	Universal	Danfoss	Emerson	Henry	Parker
3/8	8	A 17388	A 19002	HPF-083	DAS083VV			
3/8	16	A 17390	A 19007	HPF-163	DAS163VV			
1/2	16	A 17983	A 19008	HPF-164	DAS164VV			
1/2	16	A 17983	A 19008	HPF-164	DAS164VV			
5/8	16	A 17984	A 19009	HPF-165	DAS165VV			
5/8	16	A 17984	A 19009	HPF-165	DAS165VV			

DRYMASTER® Heat Pump Driers

Solder Connection

Size	Dess. Cu In	Mueller	Mueller High Capacity	Universal	Danfoss	Emerson	Henry	Parker
3/8	8	A 17389	A 19000	HPS-083	DAS083SVV			
3/8	16	A 17391	A 19004	HPS-163	DAS163SVV			
1/2	16	A 17392	A 19005	HPS-164	DAS164SVV			
5/8	16	A 17985	A 19006	HPS-165	DAS165SVV			

Competitive Cross Reference

Replaceable Filter Drier Core and Shells

DRYMASTER® Filter Drier Cores

High Capacity Core

Size	Dess. Cu In	Mueller	Danfoss	Emerson	Henry	Parker	Sporlan
48		P 36818	48DC, 48DM	H-48, HX-48	S-848-CM	PCK-48, PCX-48, Z-48	RCW-48
48		P 37267		W-48-HH	S-848-CC	PCK-48HH	RC-4864-HH
48		A 18733	48F	F-48R	S-848-F	PFE-48BF	RPE-48-BD
48		P 37266	48-DA	D-48		PCK-48	RC-4864

DRYMASTER® Filter Driers

Replaceable Core Shells

Size	Dess. Cu In	Mueller	Danfoss	Emerson	Henry	Parker	Sporlan
5/8		A 18583	DCR 485	STAS 485T	SRC-485	P 485	C 485 G
7/8		A 18584	DCR 487	STAS 487T	SRC-487	P 487	C 487 G
1 1/8		A 18585	DCR 489	STAS 489T	SRC-489		C 489 G
1 3/8		A 18586	DCR 4811	STAS 4811T, STAS 4811SV	SRC-4811	P 4811	C 4811 G
1 5/8		A 18587	DCR 4813	STAS 4813SV, STAS 4813T	SRC-4813	P 4813	C 4813 G
2 1/8		A 18588	DCR 4817	STAS 4817SV	SRC-4817	P 4817	
2 5/8		A 18664	DCR 4821	STAS 4821SV		P 4821	
7/8		A 18589	DCR 967	STAS 967T	SRC-967	P 967, P 489	C 967 G
1 3/8		A 18608	DCR 19211	STAS 19211T	SRC-19211	P 19211	C 19211 G
1 5/8		A 18609	DCR 19213	STAS 19213T	SRC-19213	P 19213	C 19213 G
2 1/8		A 18610	DCR 19217	STAS 19217T	SRC-19217	P 19217	C 19217 G
2 1/8		A 18593	DCR 9617	STAS 9617T, STAS 9617SV	SRC-9617	P 9617	
1 1/8		A 18590	DCR 969	STAS 969T	SRC-969	P 969	C 969 G
1 3/8		A 18591	DCR 9611	STAS 9611T	SRC-9611	P 9611	C 9611 G
1 5/8		A 18592	DCR 9613	STAS 9613T	SRC-9613	P 9613	C 9613 G
1 1/8		A 18604	DCR 1449	STAS 1449T	SRC-1449	P 1449	C 1449 G
1 3/8		A 18605	DCR 14411	STAS 14411T	SRC-14411	P 14411	C 14411 G
1 5/8		A 18606	DCR 14413	STAS 14413T	SRC-14413	P 14413	C 14413 G
2 1/8		A 18607	DCR 14417	STAS 14417T	SRC-14417	P 14417	
2 5/8		A 18665	DCR 9621	STAS 9621SV		P 9621	

Competitive Cross Reference

Sight Glass/Moisture Indicators

Sight Glass/ Moisture Indicators						
Hermetically Sealed, Copper Body, Solder x Solder						
Size	Mueller	Universal	Danfoss	Emerson	Henry	Parker
1 3/8	A 18121		020-4000			
1 1/8	A 18120			065411		
1 5/8	A 18122					
2 1/8	A 18123					

Sight Glass/ Moisture Indicators						
Hermetically Sealed, Flare x Flare						
Size	Mueller	Universal	Danfoss	Emerson	Henry	Parker
5/8	A 18104			065394		
1/2	A 18103			065393		
3/8	A 18102			065392		
1/4	A 18101			065391		

Sight Glass/ Moisture Indicators						
Hermetically Sealed, Flare x Swivel						
Size	Mueller	Universal	Danfoss	Emerson	Henry	Parker
1/2	A 18112					
5/8	A 18113					
3/8	A 18111					

Sight Glass/ Moisture Indicators						
Hermetically Sealed, M X F Flare						
Size	Mueller	Universal	Danfoss	Emerson	Henry	Parker
1/4	A 18106			065396		
3/8	A 18107			065397		
1/2	A 18108			065398		

Sight Glass/ Moisture Indicators						
Hermetically Sealed, Solder x Solder Extended Tube						
Size	Mueller	Universal	Danfoss	Emerson	Henry	Parker
5/8	A 18117			065408		
3/8	A 18115			065406		
1/4	A 18114			065405		
1/2	A 18116			065407		
7/8	A 18119			065410		
3/4	A 18118			065409		

Sight Glass/ Moisture Indicators						
Replaceable Element, Copper Body, Solder x Solder						
Size	Mueller	Universal	Danfoss	Emerson	Henry	Parker
2 1/8	A 18127			061032		
1 1/8	A 18124			060853		
1 5/8	A 18126			061031		
1 3/8	A 18125			061030		

Competitive Cross Reference

45° Flare Fittings

Universal	Mueller	Universal	Mueller	Universal	Mueller	Universal	Mueller
B1-3	A 04737	N4-6	A 00441	T2-8	A 00344	U3-10C	A 04929
B1-4	A 00414	N4-8	A 00442	T2-10	A 04541	U3-10D	A 04819
B1-5	A 04935	N4-10	A 01112	T2-12	A 04749	U3-10E	A 04977
B1-6	A 00415	N4-12	A 04731	T3-4A	A 00127	U3-8C	A 04727
B1-8	A 00416	N5-4	A 04544	T3-4B	A 04998	U3-8D	A 04728
B1-10	A 00485	N5-5	A 04758	T3-6B	A 00133	U4-4	A 00385
B1-12	A 04738	N5-6	A 04545	T3-6C	A 04941	U4-6	A 00386
B2-3	A 05156	N5-8	A 04546	T3-8C	A 04778	U4-8	A 00387
B2-4	A 00401	N5-10	A 04560	T3-8D	A 04944	UR2-106	A 05334
B2-5	A 04811	N5-12	A 04951	T3-10D	A 04779	UR2-108	A 04846
B2-6	A 00402	NFT5-4	A 16447	T6-4	A 06330	UR2-1210	A 04784
B2-8	A 00403	NFT5-6	A 16448	TR2-46	A 04994	UR2-128	A 04734
B2-10	A 05186	NRS4-43	A 05132	TR2-64	A 04574	UR2-43	A 05270
B2-12	A 04822	NRS4-54	A 05247	TR2-68	A 04547	UR2-54	A 08730
E1-4A	A 00335	NRS4-64	A 05140	TR2-84	A 04558	UR2-64	A 01171
E1-4B	A 04890	NRS4-65	A 05282	TR2-86	A 04559	UR2-65	A 04981
E1-4C	A 04812	NRS4-86	A 05141	TR2-810	A 04991	UR2-84	A 00356
E1-6A	A 04937	NRS4-108	A 05228	U1-3A	A 01117	UR2-86	A 00149
E1-6B	A 00337	NS4-3	A 05238	U1-4A	A 00330	UR3-1012	A 04878
E1-6C	A 04889	NS4-4	A 05051	U1-4B	A 04585	UR3-108	A 04770
E1-6D	A 04886	NS4-5	A 05239	U1-4C	A 01197	UR3-1210	A 04826
E1-8B	A 05044	NS4-6	A 05052	U1-4D	A 04628	UR3-43	A 05147
E1-8C	A 00339	NS4-8	A 05053	U1-5A	A 00331	UR3-46	A 05041
E1-8D	A 04887	NS4-10	A 05157	U1-5B	A 05036	UR3-48	A 08127
E1-8E	A 05072	NS4-12	A 05222	U1-5C	A 01198	UR3-64	A 00479
E1-10C	A 04856	P2-3	A 05045	U1-6A	A 05003	UR3-68	A 04888
E1-10D	A 04538	P2-4	A 00121	U1-6B	A 00332	UR3-810	A 04879
E1-10E	A 05054	P2-5	A 00124	U1-6C	A 01199	UR3-84	A 00480
E1-12D	A 04776	P2-6	A 00122	U1-6D	A 04993	UR3-86	A 00481
E1-12E	A 04746	P2-8	A 00123	U1-8A	A 05034	US3-1010	A 02258
E2-4	A 00147	P2-10	A 04536	U1-8B	A 04439	US3-1012	A 02272
E2-6	A 00146	P2-12	A 04757	U1-8C	A 00334	US3-1014	A 02378
E2-8	A 00145	P3-A	A 00250	U1-8D	A 04780	US3-108	A 03519
E2-10	A 04539	P3-B	A 00249	U1-8E	A 05066	US3-1212	A 05307
E2-12	A 04745	P3-C	A 00425	U1-10B	A 05035	US3-1214	A 05425
E3-4A	A 04630	P3-D	A 04759	U1-10C	A 01195	US3-44	A 03431
E3-4B	A 05007	P3-E	A 05004	U1-10D	A 04540	US3-45	A 03466
E3-6B	A 04632	P3-F	A 04850	U1-10E	A 04827	US3-46	A 03494
E4-44	A 04898	R1-AB	A 08756	U1-12C	A 05005	US3-610	A 06601
E4-66	A 08082	R1-BA	A 00630	U1-12D	A 04739	US3-64	A 03443
E4-88	A 04897	R1-CB	A 00631	U1-12E	A 04740	US3-65	A 03464
ES2-44	A 03449	R1-DB	A 00492	U2-3	A 04621	US3-66	A 03492
ES2-66	A 03511	R1-DC	A 00632	U2-4	A 00325	US3-68	A 03547
ES2-68	A 07852	R1-EC	A 00493	U2-5	A 00326	US3-810	A 02259
ES2-88	A 07851	R1-ED	A 00633	U2-6	A 00327	US3-86	A 03504
ES2-1010	A 06611	T1-4A	A 00345	U2-8	A 00329	US3-88	A 03546
ES4-44	A 15940	T1-4B	A 04859	U2-10	A 04845	US4-10	A 13568
ES4-66	A 15941	T1-4C	A 04771	U2-12	A 04733	US4-4	A 13563
ES4-88	A 15943	T1-6B	A 00347	U3-4A	A 04622	US4-5	A 13564
ES4-1010	A 15944	T1-6C	A 04922	U3-4B	A 04625	US4-6	A 13565
K1-1	A 08073	T1-8B	A 05246	U3-4C	A 04961	US4-8	A 13567
K1-3	A 08274	T1-8C	A 00349	U3-6A	A 04927	US5-1010	A 15728
K1-5	A 08276	T1-8D	A 04924	U3-6B	A 04624	US5-1212	A 15729
K1-8	A 08166	T1-10D	A 04754	U3-6C	A 04627	US5-44	A 15725
N4-4	A 00440	T2-4	A 00340	U3-6D	A 08104	US5-66	A 15726
N4-5	A 01110	T2-6	A 00342	U3-8B	A 04928	US5-88	A 15727

Cross Reference

Inactive Part Number Replacements

INACTIVE	ACTIVE	DESCRIPTION
A 04597	A 16474	Seal Cap & Gasket
A 16317	B 34552	7/8 Brass Compressor Valve
A 16600	A 18184	1/4 FL DRYMASTER Plus Drier 3 CU IN
A 16601	A 18185	3/8 FL DRYMASTER Plus Drier 3 CU IN
A 16606	A 18186	1/4 FL DRYMASTER Plus Drier 5 CU IN
A 16607	A 18187	3/8 FL DRYMASTER Plus Drier 5 CU IN
A 16608	A 18188	1/4 FL DRYMASTER Plus Drier 8 CU IN
A 16609	A 18189	3/8 FL DRYMASTER Plus Drier 8 CU IN
A 16610	A 18190	1/2 FL DRYMASTER Plus Drier 8 CU IN
A 16612	A 18191	1/4 FL DRYMASTER Plus Drier 16 CU IN
A 16613	A 18192	3/8 FL DRYMASTER Plus Drier 16 CU IN
A 16614	A 18193	1/2 FL DRYMASTER Plus Drier 16 CU IN
A 16615	A 18194	5/8 FL DRYMASTER Plus Drier 16 CU IN
A 16618	A 18195	3/8 FL DRYMASTER Plus Drier 30 CU IN
A 16619	A 18196	1/2 FL DRYMASTER Plus Drier 30 CU IN
A 16620	A 18197	5/8 FL DRYMASTER Plus Drier 30 CU IN
A 16623	A 18198	3/8 FL DRYMASTER Plus Drier 41 CU IN
A 16624	A 18199	1/2 FL DRYMASTER Plus Drier 41 CU IN
A 16625	A 18200	5/8 FL DRYMASTER Plus Drier 41 CU IN
A 16640	A 18598	1/4 SD DRYMASTER Plus Drier 3 CU IN
A 16641	A 18599	3/8 SD DRYMASTER Plus Drier 3 CU IN
A 16646	A 18654	1/4 SD DRYMASTER Plus Drier 5 CU IN
A 16647	A 18655	3/8 SD DRYMASTER Plus Drier 5 CU IN
A 16648	A 18656	1/4 SD DRYMASTER Plus Drier 8 CU IN
A 16649	A 18657	3/8 SD DRYMASTER Plus Drier 8 CU IN
A 16650	A 18658	1/2 SD DRYMASTER Plus Drier 8 CU IN
A 16653	A 18699	3/8 SD DRYMASTER Plus Drier 16 CU IN
A 16654	A 18700	1/2 SD DRYMASTER Plus Drier 16 CU IN
A 16655	A 18701	5/8 SD DRYMASTER Plus Drier 16 CU IN
A 16656	A 18703	7/8 SD DRYMASTER Plus Drier 16 CU IN
A 16657	A 18702	3/4 SD DRYMASTER Plus Drier 16 CU IN
A 16658	A 18741	3/8 SD DRYMASTER Plus Drier 30 CU IN
A 16659	A 18742	1/2 SD DRYMASTER Plus Drier 30 CU IN
A 16660	A 18743	5/8 SD DRYMASTER Plus Drier 30 CU IN
A 16661	A 18745	1 1/8 SD DRYMASTER Plus Drier 30 CU IN
A 16662	A 18744	7/8 SD DRYMASTER Plus Drier 30 CU IN
A 16663	A 18746	3/8 SD DRYMASTER Plus Drier 41 CU IN
A 16664	A 18747	1/2 SD DRYMASTER Plus Drier 41 CU IN
A 16665	A 18748	5/8 SD DRYMASTER Plus Drier 41 CU IN
A 16667	A 18749	7/8 SD DRYMASTER Plus Drier 41 CU IN
A 17260	AP17860C	3/8 Ball Valve Drilled & Tapped
A 17261	AP17861C	1/2 Ball Valve Drilled & Tapped
A 17262	AP17862C	5/8 Ball Valve Drilled & Tapped
A 17263	AP17863	3/4 Ball Valve Drilled & Tapped
A 17264	AP17864C	7/8 Ball Valve Drilled & Tapped
A 17265	AP17865	1 1/8 Ball Valve Drilled & Tapped
A 17266	A 17866	1 3/8 Ball Valve Standard
A 17267	A 17867	1 5/8 Ball Valve Standard
A 17268	A 17868	2 1/8 Ball Valve Standard
A 17269	A 17871	2 5/8 Ball Valve Standard (Reduced Port)
A 17270	A 17872	3 1/8 Ball Valve Standard (Reduced Port)
A 17388	A 19002	3/8 Flare, 8 Cu. In. Heat Pump Drier
A 17389	A 19000	3/8 Solder, 8 Cu. In. Heat Pump Drier
A 17390	A 19007	3/8 Flare, 16 Cu. In. Heat Pump Drier
A 17391	A 19004	3/8 Solder, 16 Cu. In. Heat Pump Drier
A 17392	A 19005	1/2 Solder, 16 Cu. In. Heat Pump Drier
A 17460	AQ17860C	3/8 Ball Valve Drilled & Tapped, Access Port
A 17461	AQ17861C	1/2 Ball Valve Drilled & Tapped, Access Port
A 17462	AQ17862C	5/8 Ball Valve Drilled & Tapped, Access Port
A 17463	AQ17863	3/4 Ball Valve, Drilled & Tapped, Access Port
A 17464	AQ17864C	7/8 Ball Valve Drilled & Tapped, Access Port

INACTIVE	ACTIVE	DESCRIPTION
A 17466	AC17866	1 3/8 Ball Valve, Standard with Access Port
A 17467	AC17867	1 5/8 Ball Valve, Standard with Access Port
A 17468	AC17868	2 1/8 Ball Valve, Standard with Access Port
A 17469	AC17871	2 5/8 Ball Valve, Standard with Access Port
A 17470	AC17872	3 1/8 Ball Valve, Standard with Access Port
A 17501	AP17859	1/4 Ball Valve Drilled & Tapped
A 17539	AU17860	3/8 3-Way Ball Valve w/ Access
A 17540	AU17861	1/2 3-Way Ball Valve w/ Access
A 17541	AU17862	5/8 3-Way Ball Valve w/ Access
A 17543	AU17864	7/8 3-Way Ball Valve w/ Access
A 17544	AU17865	1 1/8 3-Way Ball Valve w/ Access
A 17547	AU17868	2 1/8 3-Way Ball Valve w/ Access
A 17548	AU17871	2 5/8 3-Way Ball Valve w/ Access
A 17563	AQ17860C	3/8 Ball Valve Drilled & Tapped, Access Port
A 17564	AQ17861C	1/2 Ball Valve Drilled & Tapped, Access Port
A 17565	AQ17862C	5/8 Ball Valve Drilled & Tapped, Access Port
A 17567	AQ17864C	7/8 Ball Valve Drilled & Tapped, Access Port
A 17568	AQ17865	1 1/8 Ball Valve Drilled & Tapped, Access Port
A 17569	AC17866	1 3/8 Ball Valve, Standard with Access Port
A 17570	AC17867	1 5/8 Ball Valve, Standard with Access Port
A 17571	AC17868	2 1/8 Ball Valve, Standard with Access Port
A 17572	AC17871	2 5/8 Ball Valve, Standard with Access Port
A 17573	AC17872	3 1/8 Ball Valve, Standard with Access Port
A 17699	AQ17860C	3/8 Ball Valve Drilled & Tapped, Access Port
A 17700	AQ17861C	1/2 Ball Valve Drilled & Tapped, Access Port
A 17701	AQ17862C	5/8 Ball Valve Drilled & Tapped, Access Port
A 17702	AQ17863	3/4 Ball Valve, Drilled & Tapped, Access Port
A 17703	AQ17864C	7/8 Ball Valve Drilled & Tapped, Access Port
A 17704	AQ17865	1 1/8 Ball Valve Drilled & Tapped, Access Port
A 17705	AC17866	1 3/8 Ball Valve, Standard with Access Port
A 17706	AC17867	1 5/8 Ball Valve, Standard with Access Port
A 17707	AC17868	2 1/8 Ball Valve, Standard with Access Port
A 17708	AC17871	2 5/8 Ball Valve, Standard with Access Port
A 17709	AC17872	3 1/8 Ball Valve, Standard with Access Port
A 17711	AU17860	3/8 3-Way Ball Valve w/ Access
A 17712	AU17861	1/2 3-Way Ball Valve w/ Access
A 17713	AU17862	5/8 3-Way Ball Valve w/ Access
A 17714	AU17863	3/4 3-Way Ball Valve w/ access
A 17715	AU17864	7/8 3-Way Ball Valve w/ Access
A 17716	AU17865	1 1/8 3-Way Ball Valve w/ Access
A 17759	AP17859	1/4 Ball Valve Drilled & Tapped
A 17760	AP17860C	3/8 Ball Valve Drilled & Tapped
A 17761	AP17861C	1/2 Ball Valve Drilled & Tapped
A 17762	AP17862C	5/8 Ball Valve Drilled & Tapped
A 17763	AP17863	3/4 Ball Valve Drilled & Tapped
A 17764	AP17864C	7/8 Ball Valve Drilled & Tapped
A 17765	AP17865	1 1/8 Ball Valve Drilled & Tapped
A 17766	AP17866	1 3/8 Ball Valve Drilled & Tapped
A 17767	AP17867	1 5/8 Ball Valve Drilled & Tapped
A 17768	AP17868	2 1/8 Ball Valve Drilled & Tapped
A 17769	AP17871	2 5/8 Ball Valve Drilled & Tapped
A 17786	A 17869	2 5/8 Ball Valve Standard (Full Flow)
A 17787	AC17869	2 5/8 Ball Valve, Standard with Access Port (Full Flow)
A 17793	AW17861	1/2 Actuated Ball Valve, Standard
A 17794	AW17862	5/8 Actuated Ball Valve, Standard
A 17795	AW17863	3/4 Actuated Ball Valve, Standard
A 17796	AW17864	7/8 Actuated Ball Valve, Standard
A 17797	AW17865	1 1/8 Actuated Ball Valve, Standard
A 17798	AW17866	1 3/8 Actuated Ball Valve, Standard
A 17799	AW17867	1 5/8 Actuated Ball Valve, Standard
A 17800	AW17868	2 1/8 Actuated Ball Valve, Standard

Cross Reference

Inactive Part Number Replacements

INACTIVE	ACTIVE	DESCRIPTION
A 17801	AW17871	2 5/8 Actuated Ball Valve, Standard
A 17802	AW17872	3 1/8 Actuated Ball Valve, Standard
A 17805	AY17861	1/2 3-way Actuated Ball Valve
A 17806	AY17862	5/8 3-way Actuated Ball Valve
A 17807	AY17863	3/4 3-way Actuated Ball Valve
A 17808	AY17864	7/8 3-way Actuated Ball Valve
A 17809	AY17865	1 1/8 3-way Actuated Ball Valve
A 17812	AY17868	2 1/8 3-way Actuated Ball Valve
A 17813	AY17871	2 5/8 3-way Actuated Ball Valve
A 17814	AY17872	3 1/8 3-way Actuated Ball Valve
A 17859	AP17859	1/4 Ball Valve Drilled & Tapped
A 17860	AP17860C	3/8 Ball Valve Drilled & Tapped
A 17861	AP17861C	1/2 Ball Valve Drilled & Tapped
A 17862	AP17862C	5/8 Ball Valve Drilled & Tapped
A 17863	AP17863	3/4 Ball Valve Drilled & Tapped
A 17864	AP17864C	7/8 Ball Valve Drilled & Tapped
A 17865	AP17865	1 1/8 Ball Valve Drilled & Tapped
A 17983	A 19008	1/2 Flare, 16 Cu. In. Heat Pump Drier
A 17984	A 19009	5/8 Flare, 16 Cu. In. Heat Pump Drier
A 17985	A 19006	5/8 Solder, 16 Cu. In. Heat Pump Drier
A 18429	A 18942	3/8 Flare x ODS Multi Split Unibody Ball Valve
A 18430	A 18948	5/8 M X F FL Multi Split Unibody Ball Valve
A 18448	A 18941	1/4" FL X 1/4" ODS Multi Split Unibody Ball Valve
A 18449	A 18943	1/2" FL X 1/2" ODS Multi Split Unibody Ball Valve
A 18451	A 18947	1/2" M X F FLARE Multi Split Unibody Ball Valve
A 18452	A 18949	3/8" FFL X 1/4" MFL Multi Split Unibody Ball Valve
A 18453	A 18950	5/8" FFL X 1/2" MFL Multi Split Unibody Ball Valve
A 18454	A 15099	Seal Cap & Gasket
A 18567	A 18567U	1/4" M X F FLARE Multi Split Unibody BV-Insulation Kit
A 18568	A 18568U	3/8 M X F FL Multi Split Unibody BV-Insulation Kit
A 18569	A 18569U	1/2" M X F FLARE Multi Split Unibody BV-Insulation Kit
A 18570	A 18570U	5/8 M X F FL Multi Split Unibody BV-Insulation Kit
A 18571	A 18571U	1/4 ODS Multi Split Unibody BV-Insulation Kit
A 18572	A 18572U	3/8 ODS Multi Split Unibody BV-Insulation Kit
A 18573	A 18573U	1/2 ODS Multi Split Unibody BV-Insulation Kit
A 18574	A 18574U	5/8 ODS Multi Split Unibody BV-Insulation Kit
A 18612	A 18612U	3/8 FFL X ODS Multi Split Unibody BV-Insulation Kit
A 18614	A 18614U	5/8 FFL X ODS Multi Split Unibody BV-Insulation Kit
A 18652	A 18652U	1/4 X 3/8 FFL X MFL Multi Split Unibody BV-Insulation Kit
A 18653	A 18653U	5/8 X 1/2 FFL X MFL Multi Split Unibody BV-Insulation Kit
AC17860	AQ17860C	3/8 Ball Valve Drilled & Tapped, Access Port
AC17861	AQ17861C	1/2 Ball Valve Drilled & Tapped, Access Port
AC17862	AQ17862C	5/8 Ball Valve Drilled & Tapped, Access Port
AC17864	AQ17864C	7/8 Ball Valve Drilled & Tapped, Access Port
AC17865	AQ17865	1 1/8 Ball Valve Drilled & Tapped, Access Port
AG17865	AG17865	1 1/8 Ball Valve Standard with fitting end/access
AP17860	AP17860C	3/8 Ball Valve Drilled & Tapped
AP17861	AP17861C	1/2 Ball Valve Drilled & Tapped
AP17862	AP17862C	5/8 Ball Valve Drilled & Tapped
AP17864	AP17864C	7/8 Ball Valve Drilled & Tapped
AP17865A	AP17865	1 1/8 Ball Valve Drilled & Tapped
AQ17860	AQ17860C	3/8 Ball Valve Drilled & Tapped, Access Port
AQ17861	AQ17861C	1/2 Ball Valve Drilled & Tapped, Access Port
AQ17862	AQ17862C	5/8 Ball Valve Drilled & Tapped, Access Port
AQ17865A	AQ17865	1 1/8 Ball Valve Drilled & Tapped, Access Port
AW17865	AW17865	1 1/8 Actuated Ball Valve, Standard
AW18423	BW33755	1/4 NPTF Pressure Relief Valve (551-700)
B 33367	B 34556	1 1/8 Brass Compressor Valve
B 33529	B 34841	1 1/8 X 1 5/8 Ball Valve
B 33530	B 34842	1 3/8 X 1 5/8 Ball Valve
B 33531	B 34843	1 5/8 X 1 5/8 Ball Valve

INACTIVE	ACTIVE	DESCRIPTION
B 33613	B 34557	7/8 Brass Compressor Valve
B 33926	B 35164	3/4OD 1 5/8 BC Comp. Valve, Straight Port, cap w/ hole
B 34124	AP17861C	1/2 Ball Valve Drilled & Tapped
B 34125	AP17862C	5/8 Ball Valve Drilled & Tapped
B 34126	AP17863	3/4 Ball Valve Drilled & Tapped
B 34127	AP17864C	7/8 Ball Valve Drilled & Tapped
B 34128	AP17865	1 1/8 Ball Valve Drilled & Tapped
B 34129	A 17866	1 3/8 Ball Valve Standard
B 34130	A 17867	1 5/8 Ball Valve Standard
B 34131	A 17868	2 1/8 Ball Valve Standard
B 34132	A 17871	2 5/8 Ball Valve Standard (Reduced Port)
B 34133	A 17872	3 1/8 Ball Valve Standard (Reduced Port)
B 34253	B 35498	3/8 ODI X 1/2 ODE Receiver Valve
B 34260	A 17870	3 1/8 Ball Valve Standard (Full Flow)
B 34312	B 35225	1 3/8 Shutoff Valve (Cap w/ Vent Hole)
B 34313	B 35226	1 5/8 Shutoff Valve (Cap w/ Vent Hole)
B 34411	B 35224	1 1/8 Solder x Solder Angle Isolation Valve (Cap w/ Vent Hole)
B 34437	A 18390	ABV Hub Kit Series 1A
B 34438	A 18392	ABV Hub Kit Series 1B
B 34439	A 18394	ABV Hub Kit Series 2C
B 34440	A 18396	ABV Hub Kit Series 2D
B 34441	A 18395	ABV Hub Kit Series 3D
B 34442	A 18395	ABV Hub Kit Series 3D
B 34839	B 32197	7/8 OD Compressor Valve, Straight Port

Order Schedule and Return Policy

The Terms and Conditions and Order Policy ("Terms") contained herein shall apply to all quotations and offers made by and purchase orders accepted by Mueller Streamline Co. These terms apply to all sales made by Mueller Streamline Co except the extent the Terms conflict with an agreement signed by Mueller and Buyer. These Terms apply in lieu of any course of dealing between the parties or usage of trade in the industry. These Terms may in some instances conflict with some of the terms and conditions affixed to the purchase order of other procurement document issued by the Buyer. In such case, the Terms contained herein shall govern, and acceptance of Buyer's order is conditioned upon Buyer's acceptance of the terms and conditions herein, irrespective of whether the Buyer accepts these conditions by a written acknowledgement, by implication, or acceptance and/or payment of products ordered hereunder. Mueller Streamline Co's failure to object to provisions contained in any communication from Buyer shall not be deemed a waiver of the provisions herein. Any changes in the Terms contained herein must specifically be agreed to in writing signed by a representative of Mueller Streamline Co. before becoming binding on either party.

Scheduling and Cancellation

Standard Product: Product is considered standard product if it is listed in the Mueller Streamline Co., general product catalog, or in published product literature sheets.

Scheduling Standard Product Orders: Manufacturer will build product according to the customers' written scheduled releases or forecasts for each order. Products scheduled to ship within a thirty-day (30) window from original ship date on P.O. are non-cancelable and may only be rescheduled one time. Products scheduled to ship within a 31-60 day window may be rescheduled, but the product must be taken within three months of the original scheduled date and may only be rescheduled one time.

Cancellation of Standard Product: If Seller determines the Product being cancelled to be Standard Product, the amount of the cancellation charge will vary according to the (a) quantity being cancelled, (b) time frame between Buyer's request to Seller to cancel and the scheduled ship date for the order, and (c) dollar amount of order being cancelled. The calculation of the exact cancellation charge will be governed by Sellers published policies as amended from time to time at Seller's discretion. In no case will the cancellation charge be less than twenty percent (20%) of the original agreed upon purchase price.

Custom Product: Product is considered custom if it is not listed in the Mueller Streamline Co.'s general product catalog or in other published product literature.

Scheduling Custom Product Orders: Manufacturer will build product according to the customers' written scheduled releases or forecasts for each order. Products scheduled to ship within a ninety (90) day window from date of request are non-cancelable. Products scheduled to ship within a 60-90 day window from date of request may be rescheduled. The product must be taken within three (3) months of the rescheduled date and may only be rescheduled one time. In the event Mueller has established a stocking program in an effort to support customer production schedules, any uniquely purchased materials, finished goods inventory, or work in process required to build modified or custom product is the responsibility of, and must be paid for by the customer in the event of a cancellation or product modification that may result in obsolete inventory.

Cancellation of Custom Products: If the Product cancelled is Custom Product, Buyer agrees to pay Seller for all of Seller out of pocket costs associated with the cancellation or modification to parts or orders including, but not limited to: (i) raw materials, (ii) work in process, (iii) finished goods inventory, (iv) inventory carrying costs, (v) scrapping and disposal fees, (vi) administrative fees, (vii) reasonable and equitable profit for Seller (collectively, "Cancellation Expenses"). In no case will the cancellation charge be less than the Seller's actual costs (including overhead and other indirect costs). The amount of cancellation charge to be paid by Buyer shall be determined at the sole discretion of Seller and may equal 100% of the amount of the order cancelled or modified. Buyer shall be entitled to receive all raw materials and work in process, and Seller agrees to ship such goods to Buyer at Buyer's expense upon receipt of payment in full or Cancellation Expenses incurred by Seller.

Expedited Order Fees: If an order is received, or quantities are increased, for a non-stocked part, without proper lead time, Buyer's expense will include applicable surcharges for inefficiencies and costs created in production and scheduling if Seller can meet requested receipt dates. Expenses shall be determined at the sole discretion of the Seller and will minimally be the greater value of \$150 or 10% of the order total.

Standard Order Information

Minimum Order Requirements: A minimum charge of \$50 net applies to all orders from Mueller Streamline Co. Orders less than this amount may be subject to special charges or requirements.

Package Requirements: Standard cataloged parts must be ordered in packaged quantities. If the order does not comply, Mueller Streamline Co. reserves the right to increase or decrease to the nearest standard package quantity.

Order Visibility: The customer recognizes that Mueller Streamline Co. requires visibility to complete an order in an accurate and timely manner. Depending on the part ordered, quantity required and stock on hand, the customer will be provided with lead-time information at the time of order.

Emergency Orders: Mueller Streamline Co. reserves the right to charge a special service fee for orders that are placed with short lead-time or considered emergency requirements. The charge may include a standard order fee for the entire order, a per piece fee for each part ordered, or fees to cover extraordinary costs including overtime or scheduling charges.

Special Order Information

Minimum Order Requirements: A minimum charge of \$100 net and 25 pieces minimum applies to all orders. Orders less than this amount may be subject to special charges or requirements.

Package Requirements: Depending on the part, specialized packaging may require adjustments to the order quantities to meet appropriate packaged quantities. This is subject to inquiry at the time of the order.

Order Visibility: Due to the nature of special orders, the customer recognizes Mueller Streamline Co. may not have stock available at the time of order. Due to this, Mueller Streamline Co. will require a minimum of 2 weeks to process any new part orders. Depending on the part ordered, quantity required and stock on hand, the customer may be provided with better lead-time information at the time of order.

Emergency Orders: Mueller Streamline Co. reserves the right to charge a special service fee for orders that are placed with short lead-time or considered emergency requirements. The charge may include a standard order fee for the entire order, a per piece fee for each part ordered, or fees to cover extraordinary costs including overtime or scheduling charges.

Return Policy

Return Requests: All returns to Mueller Streamline Co. must be issued a Return Material Authorization (RMA) number prior to the return of the product. The number will be provided by a Customer Service Representative. Mueller Streamline Co. reserves the right to refuse any product that has not been accompanied by an RMA number. All buyer/credit requests are to be made within 12 months of the Buyer's receipt of goods. Buyer shall provide specific original purchase information or documentation for all RMA/Credit requests. If no such information can be provided, Seller reserves the right to establish all RMA/Credit pricing.

Stocking Fees: Buyer shall assume a minimum 20% restock fee for all returns of current product where no fault was attributable to the Seller. Product must be returned in original packaging, unused, and be packaged to eliminate any possibility of damage in shipment. Mueller Streamline Co. may opt to charge a higher fee, depending on the part being returned, the quantity, or the age of the product. At any time, Mueller may decide that it will not allow the return of product based on its discretion.

Package and Shipping Requirements: The seller reserves the right to refuse returned product that upon inspection by the Seller is determined to be in "non-sellable" condition. Unless authorized by the Seller on a Mueller Streamline Co. RMA, the Buyer shall assume all return freight charges. In Seller authorized exceptions, only Mueller Streamline Co. approved carrier may be used. Any freight damaged or shipment shortage issues must be presented to the freight carrier or Seller within 15 days of the Buyer's receipt of goods.

Terms and Conditions of Sale

THE FOLLOWING CONSTITUTE THE TERMS AND CONDITIONS OF SALE FOR ALL PRODUCTS MANUFACTURED, DISTRIBUTED AND/OR SOLD BY MUELLER STREAMLINE CO. (SELLER).

ACCEPTANCE OF SELLER'S OFFER TO SELL OR BUYER'S ORDER IS EXPRESSLY MADE CONDITIONAL ON BUYER'S ACCEPTANCE OF THE PROVISIONS STATED HEREIN. BUYER'S ACCEPTANCE OF EACH SHIPMENT OF GOODS SHALL BE DEEMED TO BE AN ACCEPTANCE OF THE PROVISIONS HEREOF NOTWITHSTANDING ANY ACT OF SELLER, INCLUDING SHIPMENT, ACCEPTANCE OF PAYMENTS, AND NOTWITHSTANDING ANY TERM OR CONDITION CONTAINED IN ANY FORM OF BUYER, AND ANY PROPOSAL FOR ADDITIONAL OR DIFFERENT TERMS OR ANY ATTEMPT BY BUYER TO VARY ANY OF THE PROVISIONS HEREIN IS HEREBY DEEMED A MATERIAL ALTERATION AND REJECTED. THE PROVISIONS HEREIN MAY NOT BE ADDED TO, MODIFIED, SUPERSEDED, OR ALTERED EXCEPT BY WRITTEN AGREEMENT OR MODIFICATION SIGNED BY AN OFFICER OF SELLER, NOTWITHSTANDING ANY TERMS WHICH MAY NOW OR IN THE FUTURE APPEAR ON BUYER'S FORMS OR COMMUNICATIONS, ALL OF WHICH ARE REJECTED WITHOUT FURTHER ACTION OF SELLER.

NO PERSON (EXCEPT AN OFFICER OF SELLER) IS AUTHORIZED TO BIND SELLER TO ANY ORDER FOR ANY GOODS EXCEPT ACCORDING TO THE PROVISIONS HEREIN.

1. PRICES. All prices for SELLER's products are subject to change or withdrawal without notice. Unless otherwise stated by SELLER, prices, terms of payment and pricing policies will be those of the SELLER in effect at the time of shipment. SELLER reserves the right to make price changes within the periods of contracts, including installment contracts or blanket orders. The cost of packing and crating other than in accordance with the standards of SELLER may constitute an additional charge and may at SELLER's discretion be added to the sales price(s). SELLER also reserves the right to divide Buyer's order into separate shipments and to invoice and otherwise treat each shipment as a separate contract subject to these Terms and Conditions. All sales and shipments are subject at all times to credit approval by SELLER.

2. TRANSPORTATION AND RISK OF LOSS. Unless otherwise agreed in advance in writing by SELLER, delivery of products hereunder shall be F.O.B. shipping point, with transportation expenses paid by Buyer unless standard SELLER freight prepayment qualifications are met and the risk of loss or damage to products in transit shall fall upon Buyer (whose responsibility it shall be to file claims with carrier at delivery to Buyer at Buyer's premises) upon delivery (a) to Buyer's designated representative, or (b) to a common carrier or other designated shipper (not including SELLER), whichever of the foregoing occurs earlier. SELLER in its discretion shall select the appropriate transportation method and routing. All orders, unless otherwise agreed in writing, are for shipment at SELLER's earliest convenience. Stated delivery dates are approximate and will be calculated from the date that SELLER has received all information necessary to permit SELLER to proceed with work immediately and without interruption. If any or all products are not delivered when ready due to the request of Buyer, SELLER reserves the right to invoice Buyer at any time thereafter and to place such products in storage with all risk of loss or damage borne by Buyer and with all expenses and costs attributable thereto for the account of Buyer, which shall be payable by Buyer upon submission of SELLER's invoices to Buyer.

3. DELAYS. SELLER shall not be liable for any delays in delivery due or resulting in whole or in part from or made impossible or impractical by any cause beyond the control of SELLER including but not limited to fire, explosion, epidemics, accident, material and significant breakdown, strike or labor disputes, adverse weather conditions, loss or damage in shipment, shortage or lack of materials, fuel or power, sale or transfer of manufacturing facilities, embargo, acts of God, acts (including delay or failure to act) of any governmental authority (de jure or de facto) or any other contingency or delay or failure or cause beyond SELLER's control. If, due to any such occurrence, SELLER is unable to supply total demands for any goods specified, SELLER may, but shall not be obligated to, allocate production, inventory and deliveries (in any manner fair and reasonable to the extent that goods are not special or unique) and will notify Buyer reasonably that there will be delay or non-delivery.

4. TAXES. All prices are exclusive of any applicable foreign or U.S.A. federal, state or local sales, use, excise or other taxes, which SELLER may be required to pay or collect, under any existing or future law, upon or with respect to the sale, delivery, storage, processing, use or consumption of any of the products covered hereby, which shall be for the account of Buyer, who shall promptly pay the amount thereof to SELLER upon demand.

5. PAYMENT TERMS AND SECURITY INTEREST. Payment terms are set forth in SELLER's quotation to BUYER. All payments not made within such time may be subject to a carrying charge of one percent per month on the unpaid balance or the highest rate permitted by applicable law, whichever is less. Until the entire amount due hereunder is paid, SELLER reserves a security interest in all products sold, with all rights, privileges and remedies of a selling secured party in the jurisdiction to which the goods may be shipped or within which they may be kept at any time. In pursuance thereof, Buyer agrees to timely execute any documents that SELLER may request from time to time in order to give notice of, perfect or otherwise give effect to the existence of said security interest.

6. TERMINATION. Any cancellations, changes, or terminations by Buyer received after order placement will be subject to Seller's approval and payment by Buyer of all actual expenses incurred or for which Seller has become obligated related to the affected goods. Seller may terminate any order or any part thereof upon written notice to Buyer. Buyer waives all claims to damages upon such termination, including, without limitation, any cost of cover to obtain substitute goods.

7. PERMISSIBLE VARIATIONS. Seller reserves the right to ship and Buyer agrees to accept, overages or shortages of up to 10% of the quantity ordered by Buyer and any such overage or shortage will be charged or credited to Buyer.

8. FINANCIAL RESPONSIBILITY. If Seller has any reasonable doubt at any time as to Buyer's financial condition and ability to perform, Seller, at its option, may (a) decline to make further shipments other than on a cash in advance basis or upon Buyer providing other security satisfactory to Seller, or (b) terminate this agreement.

9. RECEIVING AND INSPECTION. Any claim by Buyer based upon or relating to any claimed defect in the products ascertainable upon visual inspection thereof, including without limitation any claim relating to size, type, quantity or shipping damage and the like, must be presented to SELLER or its representative within fifteen (15) days following the date of receipt of the product by Buyer. Buyer's receipt of any product delivered hereunder shall be an unqualified acceptance, and a waiver by Buyer of any and all such claims with respect to such product unless Buyer gives SELLER notice of claim within fifteen (15) days after such receipt. Unless otherwise agreed in advance in writing by SELLER, variations in the products as to composition, dimensions, quantity and the like shall be permissible and not cause for Buyer's rejection or revocation if within prevailing industry (United States of America) standards. Buyer assumes all risk and liability for results.

10. TOOLING. Buyer will indemnify, defend and hold SELLER harmless from and against any liability, damage, loss or expense arising from the use or handling of any tooling supplied or designed by Buyer from which products are to be cast or manufactured by SELLER.

11. PATENT INDEMNITY. SELLER agrees to protect, indemnify and hold harmless the Buyer, its successors, assigns, customers and users of its products against any liability, loss, damage or expense whatsoever resulting from any infringement of any United States Letters Patent by any thing, number, material, design, composition, or processing of SELLER's origin or practice supplied by SELLER. With respect to any thing, number, material or design, composition, or processing, specified by Buyer and not of SELLER's origin or practice, BUYER agrees to save SELLER harmless from any liability, loss damage or expense whatsoever resulting from any infringement of any United States Letters Patent arising out of SELLER's making, using or selling the same for or to BUYER in fulfillment of its orders or contracts. SELLER and BUYER severally agree to notify the other in writing promptly of any charge of infringement made and of any suit brought in respect to such device or composition and to assume or tender to the other the full control of the defense or settlement of such suit in accordance herewith.

Terms and Conditions of Sale

12. **WARRANTY.** Seller warrants only to Buyer that products furnished of Seller's own manufacture will conform to prevailing (United State of America) industry standards as to quality, inspections, composition, quantity and type, and will be free from defects in workmanship and materials under normal conditions of use and service for a period of one year from the date of receipt by Buyer, or 18 months from the date of manufacture of the products. This warranty will not apply to damage resulting from normal wear, improper installation, misuse or neglect. Seller does not warrant any aspect of product representation, installation, modifications or manufacturing carried out by parties other than Seller nor does Seller's warranty extend to any products used in combination with Seller's goods, and Buyer indemnify, defend and hold harmless Seller for any loss, cost or expense to which Seller may be exposed as a result of any such activities by Buyer, Buyer's customers or other suppliers. Weight figures shown in Seller's catalogue and price sheets, and documents of sale are approximate only. Product is sold on a per unit basis not on a weight basis. Seller's sole obligation for failure to comply with this warranty will be, at its election, to repair or replace the defective product where Buyer notifies Seller and such product is made available to Seller for inspection F.O.B. Seller's facility or point of manufacture [within the year warranty period. Except to the extent that (1) descriptions of size, quality and type, which may appear on Seller invoices and other documents, and (2) statements of conformity of products with specification of certain industry, government, or professional organizations standards, which may appear as product information disclosures in Seller's literature and documents, may from time to time be construed to be express warranties,. THIS WARRANTY IS IN LIEU OF AND EXCLUDES ALL OTHER WARRANTIES, EXPRESS OR IMPLIED, INCLUDING MERCHANTABILITY AND FITNESS FOR A PARTICULAR PURPOSE.

13. **LIMITATION OF LIABILITY.** Under no circumstances will Seller's liability in the aggregate to Buyer under any legal theory, including without limitation, breach of contract or warranty, or commission of any tort, including negligence and strict liability, or claims for indemnification, exceed the invoice price for the affected product. Buyer must commence any action at law or in equity against Seller within one year after the product is delivered to Buyer. Buyer will not have any recourse against Seller for any loss, which reasonably could be prevented by cover or otherwise. Exceptions to Seller's warranty and limitation of liability provisions or waivers of the same granted by Seller will not constitute a precedent, default or waiver of Seller's rights to enforce such provisions in whole or in part in the future. SELLER WILL NOT BE LIABLE TO ANY PERSON FOR ANY INDIRECT, SPECIAL, INCIDENTAL, CONSEQUENTIAL OR OTHER DAMAGES OF ANY KIND WHATSOEVER, WHETHER ANY CLAIM OR POTENTIAL CLAIM IS BASED UPON THEORIES OF CONTRACT, NEGLIGENCE, OR TORT AND INCLUDING WITHOUT LIMITATION, SELLER WILL HAVE NO LIABILITY FOR SHIPPING CHARGES, LABOR, INSTALLATION, COSTS OR ANY OTHER LOSSES OR EXPENSES RELATED TO OR ASSOCIATED WITH THE INSPECTION, REPAIR OR REPLACEMENT OF THE WARRANTED PRODUCTS.

14. **DEFAULT.** Buyer will be in default if (a) Buyer fails to pay Seller any amount when due under this agreement, (b) Buyer otherwise fails for a period of five days after receiving written notice from Seller to fulfill or perform any provisions of this agreement, © Buyer becomes insolvent or bankrupt, or a petition is filed voluntarily or involuntarily and not dismissed within 30 days of filing, or (d) Buyer makes a general assignment for the benefit of its creditors, or a receiver is appointed, or a substantial part of Buyer's assets are attached or seized under legal process and not released within 30 days thereafter.

Upon buyer's default, Seller may, at its option, without prejudice to any of its other rights and remedies, and without demand for payments past due, (a) make shipments subject to receipt of cash in advance, (b) terminate this agreement and declare immediately due and payable the obligations of Buyer for goods previously shipped, notwithstanding any other provision in these terms and conditions, © demand reclamation, or (d) suspend any further deliveries until the default is corrected, without releasing Buyer from its obligations under this agreement. In any event, Buyer will remain liable for all loss and damage sustained by Seller because of Buyer's default.

15. **OTHER.** (a) SELLER accepts no responsibility to BUYER or to any person claiming by or through BUYER, for compliance with any statute, governmental rule or regulation made applicable to this contract by reason of BUYER's intended use of the products unless SELLER has received from BUYER prior timely written notification of such statute, rule or regulation and has accepted the same by a separate writing signed by an officer of SELLER.

(b) SELLER's forbearance or failure to enforce any of these conditions as set forth herein or to exercise any right accruing from any default of BUYER shall not affect, impair or waive SELLER's right if such default continues or if any subsequent default of BUYER occurs.

© The provisions herein constitute the entire agreement between BUYER and SELLER and no terms or conditions other than those stated herein and no agreement or understanding oral or written in any way purporting to modify these conditions shall be binding on SELLER unless hereafter made in writing and signed by SELLER's authorized representative. All orders are subject to acceptance at SELLER's offices and BUYER and SELLER's contract shall be construed in accordance with the laws of Tennessee. . Any disputes arising under these terms and conditions, and the orders to which they pertain, shall be brought exclusively in Shelby County, Tennessee.

(d) The provisions of this agreement shall be considered severable. In the event that any of the provisions, or portions or applications thereof, of this agreement are held to be unenforceable or invalid by any court of competent jurisdiction, all remaining portions shall remain in full force and effect in accordance with the spirit of this agreement.

€ The rights and obligations of BUYER and SELLER hereunder shall not be assigned to any third party without the prior written consent of the other party.

(f) ACCEPTANCE OF THE PRODUCTS SOLD HEREUNDER SHALL CONSTITUTE ASSENT TO THESE CONDITIONS AND SELLER HEREBY OBJECTS TO AND REJECTS ANY AND ALL ADDITIONAL OR DIFFERENT TERMS PROPOSED BY BUYER, WHETHER CONTAINED IN BUYER'S PURCHASING OR SHIPPING RELEASE FORMS OR ELSEWHERE. ALL PROPOSALS, NEGOTIATIONS, AND REPRESENTATIONS, IF ANY, MADE PRIOR AND WITH REFERENCE HERETO ARE MERGED HEREIN, AND ANY PROPOSED ADDITIONS, MODIFICATIONS, DELETIONS OR CHANGES NOT IN SEPARATE WRITINGS SIGNED BY AN OFFICER OF SELLER ARE REJECTED WITHOUT FURTHER ACTION BY SELLER.

Index

<u>Part Number</u>	<u>Pg</u>	<u>Part Number</u>	<u>Pg</u>	<u>Part Number</u>	<u>Pg</u>	<u>Part Number</u>	<u>Pg</u>	<u>Part Number</u>	<u>Pg</u>	<u>Part Number</u>	<u>Pg</u>	<u>Part Number</u>	<u>Pg</u>
118RBVINS	18	A 01195	71	A 04822	65	A 05282	68	A 14058	53	A 15941H	66	A 17842	19
12RBVINS	18	A 01197	71	A 04826	72	A 05299	74	A 14059	53	A 15943	66	A 17843	19
138RBVINS	18	A 01198	71	A 04827	71	A 05307	72	A 14060	53	A 15943H	66	A 17844	19
158RBVINS	18	A 01199	71	A 04845	71	A 05334	72	A 14062	53	A 16302	26	A 17845	19
218RBVINS	18	A 02258	72	A 04846	72	A 05425	72	A 14064	53	A 16303	26	A 17846	19
258RBVINS	18	A 02259	72	A 04856	66	A 06330	70	A 14833	39	A 16304	26	A 17855	8
34RBVINS	18	A 02272	72	A 04859	70	A 06601	72	A 14835	39	A 16307	27	A 17856	8
38RBVINS	18	A 02378	72	A 04878	72	A 07851	66	A 14836	39	A 16308	27	A 17856XHP	9
58RBVINS	18	A 03416	30	A 04879	72	A 08073	67	A 14837	39	A 16309	27	A 17861XHP	9
78RBVINS	18	A 03431	72	A 04886	66	A 08082	66	A 14838	39	A 16310	29	A 17862XHP	9
A 00121	69	A 03443	72	A 04887	66	A 08104	71	A 14840	39	A 16311	29	A 17864XHP	9
A 00122	69	A 03449	66	A 04888	72	A 08127	72	A 14841	39	A 16312	29	A 17865XHP	9
A 00123	69	A 03464	72	A 04889	66	A 08166	67	A 14842	39	A 16313	30	A 17866	6
A 00124	69	A 03466	72	A 04890	66	A 08261	74	A 14848	39	A 16314	30	A 17867	6
A 00127	70	A 03492	72	A 04898	66	A 08274	67	A 14850C	39	A 16315	30	A 17868	6
A 00145	66	A 03494	72	A 04927	71	A 08276	67	A 14851	39	A 16316	30	A 17869	6
A 00146	66	A 03504	72	A 04928	71	A 08314	74	A 14852	39	A 16447	68	A 17870	6
A 00147	66	A 03511	66	A 04929	71	A 08315	74	A 15073	34	A 16448	68	A 17871	6
A 00149	72	A 03519	72	A 04935	65	A 08624	74	A 15214	53	A 16472	35	A 17872	6
A 00249	69	A 03546	72	A 04937	66	A 08625	74	A 15500	29	A 17224	56	A 17908	40
A 00250	69	A 03547	72	A 04941	70	A 08626	74	A 15501	48	A 17225	56	A 17910	40
A 00325	71	A 04439	71	A 04951	68	A 08627	74	A 15502	48	A 17226	56	A 17912	40
A 00326	71	A 04536	69	A 04961	71	A 08628	74	A 15503	48	A 17227	56	A 17913	35
A 00327	71	A 04538	66	A 04977	71	A 08629	74	A 15504	48	A 17228	56	A 17921	51
A 00329	71	A 04539	66	A 04981	72	A 08630	74	A 15506	49	A 17229	56	A 17922	51
A 00330	71	A 04540	71	A 04993	71	A 08631	74	A 15508	46	A 17230	56	A 17923	51
A 00331	71	A 04544	68	A 04998	70	A 08632	74	A 15509	46	A 17231	56	A 17924	51
A 00332	71	A 04545	68	A 05003	71	A 08633	74	A 15512	45	A 17232	56	A 17934	23
A 00334	71	A 04546	68	A 05004	69	A 08730	72	A 15513	45	A 17233	56	A 17935	23
A 00335	66	A 04547	70	A 05005	71	A 08756	53	A 15514	45	A 17300	56	A 17936	23
A 00337	66	A 04559	70	A 05007	66	A 09215	74	A 15525	38	A 17301	56	A 17937	23
A 00339	66	A 04560	68	A 05034	71	A 09464	26	A 15526	38	A 17302	56	A 17938	23
A 00340	70	A 04566	75	A 05035	71	A 11030	35	A 15530	38	A 17418	31	A 17939	23
A 00342	70	A 04582	74	A 05036	71	A 11031	35	A 15531	38	A 17419	26	A 17940	23
A 00344	70	A 04585	71	A 05041	72	A 11042	35	A 15539	38	A 17420	26	A 17941	23
A 00345	70	A 04597	75	A 05044	66	A 13166	28	A 15541	38	A 17422	32	A 17942	23
A 00349	70	A 04622	71	A 05045	69	A 13183	33	A 15542	38	A 17429	34	A 17943	23
A 00356	72	A 04624	71	A 05051	68	A 13220	33	A 15580	36	A 17430	46	A 17944	23
A 00385	72	A 04625	71	A 05051H	68	A 13502	35	A 15581	36	A 17474	34	A 17965	19
A 00386	72	A 04627	71	A 05052	68	A 13503	35	A 15582	36	A 17495	32	A 17966	19
A 00387	72	A 04628	71	A 05052H	68	A 13563	73	A 15620	21	A 17502	35	A 17967	19
A 00401	65	A 04630	66	A 05053	68	A 13563H	73	A 15621	21	A 17503	35	A 17968	19
A 00402	65	A 04707	28	A 05053H	68	A 13564	73	A 15622	21	A 17506	33	A 17970	47
A 00403	65	A 04715	29	A 05054	66	A 13565	73	A 15623	21	A 17510	27	A 17971	50
A 00409	75	A 04727	71	A 05066	71	A 13565H	73	A 15628	21	A 17511	27	A 17981	23
A 00414	65	A 04728	71	A 05072	66	A 13567	73	A 15629	21	A 17512	27	A 18025	63
A 00415	65	A 04731	68	A 05074	74	A 13567H	73	A 15630	21	A 17515	29	A 18101	62
A 00416	65	A 04733	71	A 05132	68	A 13568	73	A 15631	21	A 17516	29	A 18102	62
A 00425	69	A 04734	72	A 05140	68	A 13568H	73	A 15632	21	A 17518	26	A 18103	62
A 00440	68	A 04737	65	A 05141	68	A 13591	36	A 15633	21	A 17519	26	A 18104	62
A 00441	68	A 04738	65	A 05147	72	A 13592	36	A 15634	21	A 17520	26	A 18106	62
A 00442	68	A 04739	71	A 05148	74	A 13595	36	A 15635	21	A 17525	30	A 18107	62
A 00479	72	A 04740	71	A 05150	74	A 13613	35	A 15725	73	A 17526	30	A 18108	62
A 00480	72	A 04749	70	A 05151	74	A 13977	33	A 15725H	73	A 17527	30	A 18110	62
A 00481	72	A 04757	69	A 05152	74	A 13978	33	A 15726	73	A 17529	29	A 18111	62
A 00485	65	A 04758	68	A 05157	68	A 13979	33	A 15726H	73	A 17531	27	A 18112	62
A 00492	53	A 04759	69	A 05157H	68	A 14017	53	A 15727	73	A 17532	31	A 18113	62
A 00493	53	A 04770	72	A 05186	65	A 14018	53	A 15727H	73	A 17533	31	A 18114	60
A 00630	53	A 04775	75	A 05222	68	A 14019	53	A 15728	73	A 17534	31	A 18115	60
A 00631	53	A 04778	70	A 05222H	68	A 14021	53	A 15728H	73	A 17545	15	A 18116	60
A 00632	53	A 04780	71	A 05228	68	A 14022	53	A 15729	73	A 17546	15	A 18117	60
A 00633	53	A 04784	72	A 05238	68	A 14023	53	A 15729H	73	A 17810	16	A 18118	60
A 01112	68	A 04811	65	A 05239	68	A 14024	53	A 15940	66	A 17811	16	A 18119	60
A 01117	71	A 04812	66	A 05247	68	A 14026	53	A 15940H	66	A 17834	49	A 18120	60
A 01171	72	A 04819	71	A 05270	72	A 14027	53	A 15941	66	A 17840	49	A 18121	60

Index

<u>Part Number</u>	<u>Pg</u>	<u>Part Number</u>	<u>Pg</u>	<u>Part Number</u>	<u>Pg</u>	<u>Part Number</u>	<u>Pg</u>	<u>Part Number</u>	<u>Pg</u>	<u>Part Number</u>	<u>Pg</u>	<u>Part Number</u>	<u>Pg</u>
A 18122	60	A 18540	49	A 18733C	59	A 19004	57	AW17863	16	B 34909	6	F 36700A	19
A 18123	60	A 18565C	22	A 18734	58	A 19005	57	AW17864	16	B 34910	6	F 36701	19
A 18124	61	A 18566C	22	A 18735	49	A 19006	57	AW17865	16	B 35122	53	F 36701A	19
A 18125	61	A 18567U	13	A 18736	49	A 19007	57	AW17866	16	B 35123	53	F 36702A	19
A 18126	61	A 18568U	13	A 18737	48	A 19008	57	AW17867	16	B 35124	53	F 36702A	19
A 18127	61	A 18569U	13	A 18741	55	A 19009	57	AW17868	16	B 35125	53	F 36703	19
A 18184	54	A 18570U	13	A 18742	55	A 19010	57	AW17869	16	B 35126	53	F 36703A	19
A 18185	54	A 18571U	14	A 18743	55	A 19011	57	AW17870	16	B 35133	53	F 36704A	19
A 18186	54	A 18572U	14	A 18744	55	A 19012	57	AW17871	16	B 35134	53	F 36704A	19
A 18187	54	A 18573U	14	A 18745	55	A 19013	57	AW17872	16	B 35135	53	F 36705	19
A 18188	54	A 18574U	14	A 18746	55	A 19014	57	AW18422	49	B 35160	35	F 36705A	19
A 18189	54	A 18583	58	A 18747	55	A 19021	35	AY17861	16	B 35161	35	F 36706	19
A 18190	54	A 18584	58	A 18748	55	A 19022	35	AY17862	16	B 35162	37	F 36706A	19
A 18191	54	A 18585	58	A 18749	55	A 19023	35	AY17863	16	B 35224	41	F 36707	19
A 18192	54	A 18586	58	A 18762	49	A 19042	35	AY17864	16	B 35273	51	F 36707A	19
A 18193	54	A 18587	58	A 18764	19	A 19043	52	AY17865	16	B 35284	35	MSBVINS	13
A 18194	54	A 18588	58	A 18764-KIT	19	A 19044	35	AY17868	16	B 35291	41	MSBVINS	18
A 18195	54	A 18589	58	A 18765	19	AC17866	7	AY17871	16	B 35334	37	MSBVINSCE	14
A 18196	54	A 18590	58	A 18783	48	AC17867	7	AY17872	16	B 35413	49	MSBVINSCE	18
A 18197	54	A 18591	58	A 18784	45	AC17868	7	B 32197	29	B 35514	37	N 02307	74
A 18198	54	A 18592	58	A 18800	55	AC17869	7	B 32222	35	B 35519	34	N 02308	74
A 18199	54	A 18593	58	A 18801	54	AC17870	7	B 32807	31	B 35523	37	N 02351	19
A 18200	54	A 18598	55	A 18823	55	AC17871	7	B 32808	31	B 35531	18	N 02352	19
A 18351	18	A 18599	55	A 18838	24	AC17872	7	B 32930	31	B 35532	18	N 02353	19
A 18352	18	A 18604	58	A 18844	56	AF17866XHP	9	B 33482	36	B 35533	18	N 02354	19
A 18353	18	A 18605	58	A 18845	56	AF17867XHP	9	B 33746	45	B 35534	18	N 02355	19
A 18354	18	A 18606	58	A 18846	56	AF17868XHP	9	B 33752	48	B 35535	18	N 02356	19
A 18355	18	A 18607	58	A 18856	56	AH18720	24	B 33753	48	B 35536	18	P 34627	75
A 18356	49	A 18608	58	A 18857	56	AH18721	24	B 33754	45	B 35593	37	P 34632	75
A 18357	49	A 18609	58	A 18858	56	AH18722	24	B 33755	46	F 27950	31	P 36167	40
A 18358	49	A 18610	58	A 18860	56	AH18723	24	B 33803	34	F 27955	31	P 36168	40
A 18366	19	A 18611U	12	A 18889	56	AH18724	24	B 33819	35	F 29201	31	P 36169	40
A 18367	19	A 18612U	12	A 18890	56	AH18838	24	B 33837	37	F 33957	19	P 36214	50
A 18368	19	A 18613U	12	A 18891	56	AP17859	6	B 33964	35	F 33958	19	P 36408	20
A 18368-KIT	19	A 18614U	12	A 18892	56	AP17859HP	10	B 34235	25	F 34665	32	P 36409	20
A 18368-KIT	19	A 18652U	13	A 18893	56	AP17860C	6	B 34236	25	F 35111	19	P 36410	20
A 18383C	22	A 18653U	13	A 18894	56	AP17860HP	10	B 34237	25	F 35160	19	P 36414	20
A 18387	49	A 18654	55	A 18937	14	AP17861C	6	B 34238	25	F 35161	19	P 36417	20
A 18389	19	A 18655	55	A 18938	14	AP17861HP	10	B 34239	25	F 35162	19	P 36418	20
A 18389-KIT	19	A 18656	55	A 18939	14	AP17862C	6	B 34240	25	F 35222	19	P 36419	20
A 18390	19	A 18657	55	A 18940	14	AP17862HP	10	B 34241	25	F 35222	19	P 36714	20
A 18391	19	A 18658	55	A 18941	12	AP17863	6	B 34247	34	F 35223	19	P 36723	19
A 18391-KIT	19	A 18659C	22	A 18942	12	AP17863HP	10	B 34248	35	F 35223	19	P 36762	19
A 18392	19	A 18660C	22	A 18943	12	AP17864C	6	B 34252	35	F 35224	19	P 36763	19
A 18393	19	A 18664	58	A 18944	12	AP17864HP	10	B 34254	37	F 35224	19	P 36764	19
A 18393-KIT	19	A 18665	58	A 18945	13	AP17865	6	B 34255	35	F 35427	19	P 36765	19
A 18394	19	A 18673	8	A 18946	13	AP17865HP	10	B 34261	34	F 35428	19	P 36818	59
A 18395	19	A 18674	8	A 18947	13	AP18675HP	10	B 34287	37	F 35429	19	P 36889	20
A 18396	19	A 18675	8	A 18948	13	AQ17859	7	B 34288	35	F 35430	19	P 37266	59
A 18399	19	A 18699	55	A 18949	13	AQ17860C	7	B 34412	41	F 35639	19	P 37267	59
A 18400	19	A 18700	55	A 18950	13	AQ17861C	7	B 34413	41	F 35640	19	P 37671	58
A 18400-KIT	19	A 18701	55	A 18959	11	AQ17862C	7	B 34414	40	F 35641	19	P 37717	75
A 18401	19	A 18702	55	A 18960	11	AQ17863	7	B 34415	40	F 35642	19	P 37729	20
A 18402	19	A 18703	55	A 18961	11	AQ17864C	7	B 34417	40	F 35755	19	P 37730	20
A 18402-KIT	19	A 18715C	58	A 18962	11	AQ17865	7	B 34418	40	F 35949	19	P 37731	20
A 18403	20	A 18716C	58	A 18963	11	AU17860	15	B 34425	47	F 35950	19	P 37732	20
A 18403	20	A 18717C	58	A 18964	11	AU17861	15	B 34444	49	F 35951	19	P 37733	20
A 18404	20	A 18718C	58	A 18965	11	AU17862	15	B 34519	49	F 35952	19	P 37735	20
A 18404	20	A 18719	58	A 18966	11	AU17863	15	B 34550	51	F 36322A	19	P 37736	20
A 18404	20	A 18720	24	A 18997	39	AU17864	15	B 34559	51	F 36322A	19	S 35923	75
A 18404	20	A 18721	24	A 18998	39	AU17865	15	B 34580	49	F 36451	19	S 36164	40
A 18424	49	A 18722	24	A 19000	57	AU17868	15	B 34594	41	F 36452	19	S 36171	40
A 18425	49	A 18723	24	A 19001	57	AU17871	15	B 34595	41	F 36573	19	S 36173	40
A 18444	49	A 18724	24	A 19002	57	AW17861	16	B 34654	51	F 36595	19	S 36284	75
A 18473	47	A 18730	52	A 19003	57	AW17862	16	B 34778	41	F 36700	19		



121 Rogers Street
Hartsville, TN 37074

Customer Service: (800) 251-8983
Phone: (615) 374-2124
www.muellerrefrigeration.com