

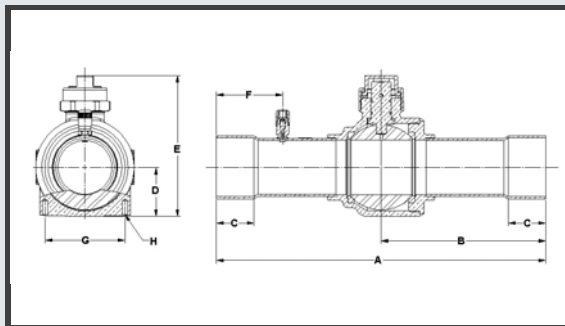

Features:

- Design Pressure (DP) / Maximum abnormal pressure (MAP): Up to 775 psig, 53 bar
- Continuous operating temperature (COT): -40°F/300°F, -40°C/149°C
- Contact factory or visit website for compatibility with CFC, HCFC, HFC and HFO refrigerants and oils
- Full port construction to match line size ID
- Internally equalized ball design
- Rupture-proof encapsulated stem
- Bi-directional flow
- MCM Seal Technology
- UL/cUL Listed, Conforms to Pressure Equipment Directive 2014/68/EU



Part Number	Size		Cv	Kv	A		B		C Min		D		E		F		G **		H **		Port (in)	MAP		Wt		Seal Cap Kit
	in	mm			in	mm	in	mm	in	mm	in	mm	in	mm	in	mm	in	mm	in	mm		psig	bar	lb	kg	
AQ17859 ‡	1/4	6	1.0	1	5.50	140	2.98	76	0.31	8	0.54	14	2.23	57	1.16	29	0.87	22	M4 X 0.7	0.50	775	53	0.52	0.23	A 17842	
AQ17860C ‡	3/8	10	4.3	4	5.50	140	2.98	76	0.31	8	0.54	14	2.23	57	1.16	29	0.87	22	M4 X 0.7	0.50	775	53	0.52	0.24	A 17842	
AQ17861C ‡	1/2	13	6.2	5	6.35	161	3.41	87	0.38	10	0.54	14	2.23	57	1.21	31	0.87	22	M4 X 0.7	0.50	775	53	0.53	0.24	A 17842	
AQ17862C ‡	5/8	17	12.1	10	6.35	161	3.41	87	0.50	13	0.54	14	2.23	57	1.35	34	0.87	22	M4 X 0.7	0.50	775	53	0.54	0.24	A 17842	
AQ17863 ‡	3/4	19	19.0	16	7.45	189	3.89	99	0.62	16	0.72	18	2.66	68	1.47	37	1.18	30	M4 X 0.7	0.75	775	53	0.92	0.42	A 17843	
AQ17864C ‡	7/8	22	27.5	24	7.45	189	3.89	99	0.75	19	0.72	18	2.66	68	1.60	41	1.18	30	M4 X 0.7	0.75	775	53	0.96	0.43	A 17843	
AQ17865 ‡	1 1/8	29	54.0	47	8.42	214	4.21	107	0.91	23	1.00	25	3.15	80	1.74	44	1.50	38	M4 X 0.7	1.00	775	53	1.66	0.75	A 17843	
AC17866	1 3/8	35	89.1	77	10.00	254	5.00	127	0.97	25	1.17	30	3.72	94	2.04	52	1.89	48	M6 X 1.0	1.25	775	53	2.62	1.19	A 17844	
AC17867	1 5/8	41	114.0	99	11.00	279	5.50	140	1.09	28	1.38	35	4.12	105	2.25	57	2.17	55	M6 X 1.0	1.50	775	53	3.68	1.67	A 17844	
AC17868	2 1/8	54	244.0	211	12.00	305	6.09	155	1.34	34	1.86	47	5.32	135	2.41	61	2.91	74	M6 X 1.0	2.00	700	48	8.09	3.67	A 17845	
AC17869	2 5/8	67	401.0	347	13.50	343	6.75	171	1.47	37	2.19	56	5.92	150	2.85	72				2.44	700	48	13.81	6.26	A 17845	
AC17870	3 1/8	79	553.0	478	16.00	406	8.00	203	1.66	42	2.69	68	7.03	179	3.41	87				3.00	700	48	21.42	9.72	A 17846	
AC17871 *	2 5/8	67	230.0	199	12.00	305	6.00	152	1.47	37	1.79	45	5.14	131	2.48	63	2.91	74	M6 X 1.0	2.00	700	48	8.71	3.95	A 17845	
AC17872 *	3 1/8	79	143.0	124	12.00	305	6.00	152	1.66	42	1.79	45	5.14	131	2.66	68	2.91	74	M6 X 1.0	2.00	700	48	9.23	4.18	A 17845	

* Reduced Port

** Where Applicable

*** Consult Factory

‡ Standard product offering includes drilled/ tapped feature

Prefix AQ Drilled/ tapped